

Sliding Sash Hardware & Weatherseals



**SASH + DOOR
HARDWARE**

What's inside

- Lead & Steel Weights
- Sash Cord
- Sash Pulleys
- Staff & Parting Bead
- Spiral Balances
- Sash Window Seals
- Sash Furniture
- Restrictors & Security



ABOUT.

HAPPY.
HELPFUL.
HONEST.



Welcome to our new Sliding Sash Hardware & Weatherseals catalogue. The first of 9 separate catalogues for each category of product we sell. We may have changed how we produce our catalogues, but you'll still get the same great service you're used to.

We believe our customer service is what sets us apart from other suppliers in the industry. The vast majority of the products we sell are available from other suppliers. So why would you choose us for your timber window and door hardware needs? At SD Hardware, we believe in building lasting relationships with our customers, based on trust and confidence. So we guarantee you'll get helpful, honest (and technical when needed) advice on the products you need, along with a fair and competitive price. We are also happy to quote for larger projects and will be as competitive as possible in all cases.

REASONS TO BUY FROM US

- Great customer service
- Trusted, friendly and personable team
- Great products at fair prices
- Low standard pricing (No price breaks)
- Bulk discounts available on request
- Priced catalogue
- Order online at trade prices

If you're a joiner that manufactures timber windows and doors and hasn't used us before, we'd love to hear from you.
Why not give us a try?!



TECHNICAL ADVICE



PRODUCT SOURCING



NEXT DAY DELIVERY

**FREE UK CARRIAGE
ON ORDERS OVER £120
(EXCLUDING SASH WEIGHTS)**

CARRIAGE CHARGES MAY ALSO
APPLY TO DIRECT DELIVERIES

Secure payments powered by

worldpay



MOST MAJOR CREDIT CARDS ACCEPTED

SDH reserve the right to change the design and specification of any item herein without notice. All measurements are in millimetres unless otherwise stated. All prices are subject to VAT. E&OE.

**SIGN UP FOR A TRADE
LOGIN ONLINE TO VIEW
TRADE PRICES AND
ADDED BENEFITS**



www.sdhardware.co.uk

 **REVIEWS.io**



4.8 / 5.0

We're rated excellent
on **reviews.io**

CONTENTS.



Qwood
BEAD INNOVATION

Featured range

Qwood on pages 08-09

WEIGHTS	05
SASH CORD & PULLEYS	06 - 07
QWOOD	08 - 09
PARTING BEADS & SEALS	10 - 11
BALANCES	12 - 13
FURNITURE & ACCESSORIES	14 - 22

Featured range

Sash Heritage on pages 17-22



TRADE DISCOUNTS.

Don't forget you are receiving a **TRADE ONLY** discount on all products. You can send your customers to our website to choose products knowing they won't see your discounted prices. This is particularly helpful for window and door furniture and can earn you some extra income in marking up to our online retail prices.

Anatomy of a Sash Window

and what **SDH** can supply

- 1. Sash Weights
- 2. Sash Cord

- 3. Pulleys
- 4. Staff & Parting Bead
- 5. Sash Seals & Pile

- 6. Spiral Balances
- 7. Furniture
- 8. Security

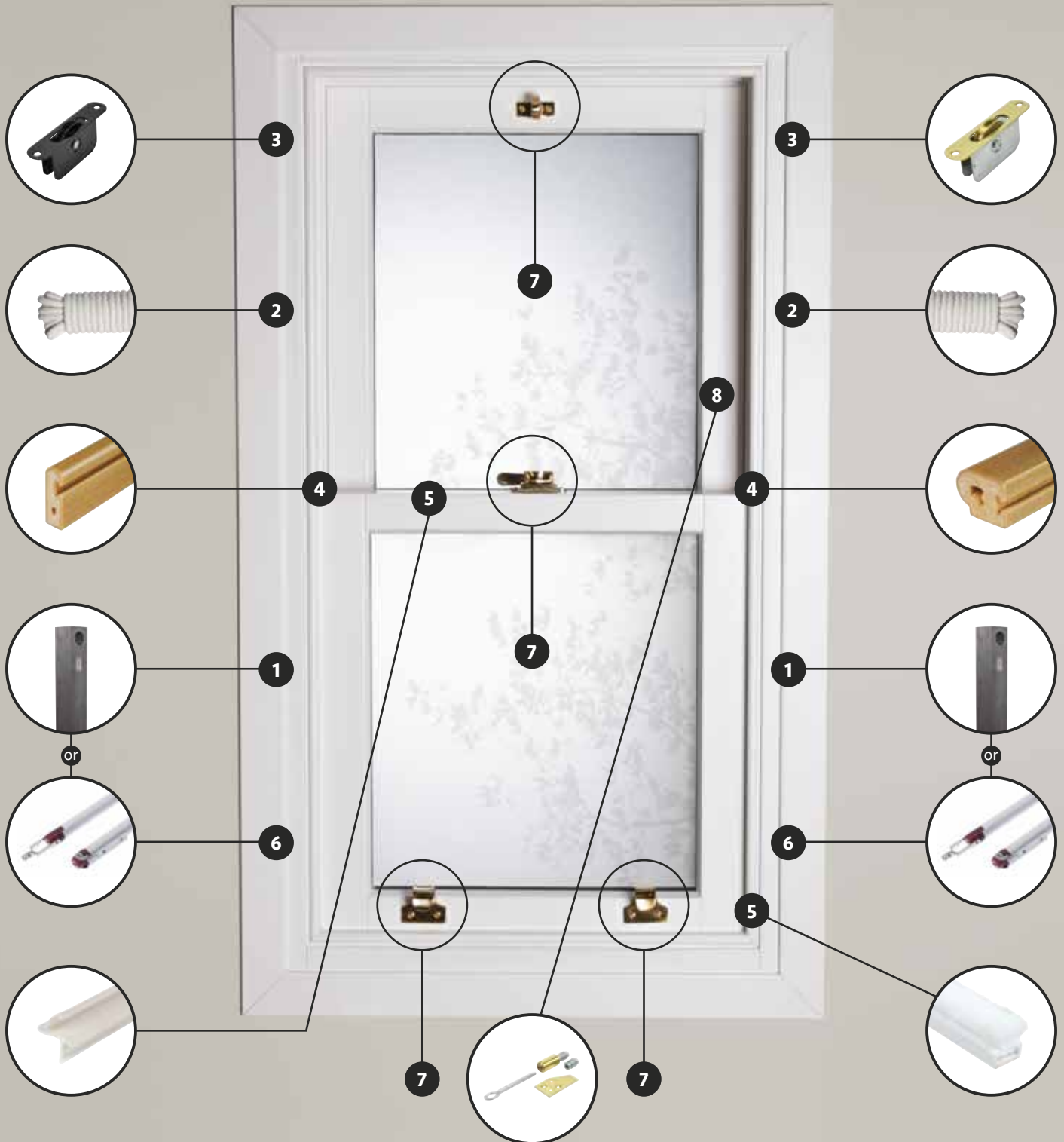

We have all bases covered at **SDH** when you're looking for the products needed to manufacture a sash window.

Please get in touch and we'll be happy to help with your next sash window project.

Steel Weights

SDH steel weights are cut to size and provide a competitive alternative to lead weights.

- Can be used in 90% of sliding sash windows
- 1-5 day delivery
- Cut to size
- Coated to inhibit rust
- Non-hazardous product

Please find weight ranges in square sizes below.

Chart shows standard stocked sizes. Other sizes can be ordered. Please allow 7-10 extra days as this is made to order.



WEIGHT	LENGTH	WIDTH
5lb	198mm	40mm
6lb	234mm	40mm
7lb	270mm	40mm
8lb	306mm	40mm
9lb	342mm	40mm
10lb	378mm	40mm
11lb	414mm	40mm
12lb	352mm	45mm
13lb	381mm	45mm
14lb	409mm	45mm
15lb	438mm	45mm
16lb	466mm	45mm
17lb	495mm	45mm
18lb	523mm	45mm
19lb	552mm	45mm
20lb	580mm	45mm
21lb	609mm	45mm
22lb	637mm	45mm
23lb	666mm	45mm
24lb	552mm	50mm
25lb	575mm	50mm
26lb	598mm	50mm
27lb	621mm	50mm
28lb	644mm	50mm
29lb	667mm	50mm
30lb	690mm	50mm
31lb	713mm	50mm
32lb	736mm	50mm

BIG SAVINGS TO BE MADE USING STEEL

LARGE STOCK HOLDING

*Correct price at time of going to print

EASY ORDER FORM AVAILABLE, PLEASE ASK OUR SALES TEAM

	WEIGHT	PRICE
40mm Square	3lb to 30lb	PLEASE CALL
45mm Square	6lb to 38lb	PLEASE CALL
50mm Square	9lb to 41lb	PLEASE CALL

97p*
per lb

CHART SHOWS EXAMPLES, FOR OTHER SIZES & WEIGHTS PLEASE ENQUIRE

ORDERS UNDER 1 TON WILL BE SUBJECT TO A CARRIAGE CHARGE, PRICE ON APPLICATION

Approximate measurements
(can be used to work out bespoke sizes)
40mm = 37mm per lb
45mm = 29mm per lb
50mm = 23mm per lb

Lead Weights

We stock lead weights in the below bar lengths.

- Pre-cut service available
- Multitude of different sizes available

DUE TO THE HUGE FLUCTUATION IN THE COST OF LEAD PLEASE CALL US FOR OUR PRICES!

PLEASE CALL FOR PRICES



ORDERS UNDER 1 TON WILL BE SUBJECT TO A CARRIAGE CHARGE, PRICE ON APPLICATION

SIZE	WEIGHT	PRICE
38-600mm	20lb	PLEASE CALL
45-600mm	27lb	PLEASE CALL

Make Weights

Dimensions (Approx):
Outer Radius: 38mm
Hole Radius: 10mm



WEIGHT	PRICE
1 lb	PLEASE CALL
1-2 lb	PLEASE CALL

Deflector Make Weights

- Designed with a tapered end to prevent suspended weights becoming caught on each other
- 30mm sq section



WEIGHT	PRICE
1 lb	PLEASE CALL

Sash Cord

This is a small selection of our very extensive range of Sash Cord. Perfect for newly produced windows or refurbishing existing projects, our Sash Cord has been carefully chosen to include the finest and most popular cords in various sizes and types, we can even produce cord in various colours to suit certain applications.

Nylon Cord

Nylon Plait Sash Cord is made from strong plaited nylon fibres making it one of our strongest sash cords.



6mm x 10m Knots

SCN-10
£5.22

Waxed Cord

Waxed Sash Cord has a natural cotton cover with a polypropylene core for strength and is waxed for long lasting, weatherproof durability.



6mm x 15m Knots

SCW-15
£5.19

Red Spot Cord

Redspot super braid Sash Cord is made from 100% natural organic cotton.



7mm x 20m Knots

SCRS-20
£13.08



6mm x 100m Rolls 8mm x 100m Rolls

SCN-100	SCN-8-100 <small>NEW</small>
£55.25	£50.23



6mm x 100m Rolls 8mm x 100m Rolls

SCW-100	SCW-8-100 <small>NEW</small>
£35.88	£50.23



7mm x 100m Rolls

SCRS-100
£55.25



SASH HERITAGE[®]
COLLECTION

Add that finishing touch to your windows with our collection of **Ball Bearing Brass Wheel Pulleys** to match our solid brass sliding sash furniture collection.

Ball Bearing Brass Wheel Pulleys

- Radius or square end faceplate
- Case Material: Galvanised Steel
- Faceplate Material: Solid Brass
- (1³/₄") Size of Plate: 118mm x 25mm
- (1³/₄") Depth of Product: 34 mm
- (2") Size of Plate : 127mm x 28mm
- (2") Depth of Product: 45 mm
- Complete with Screws



Antique Brass



Antique Nickel



Polished Brass



Polished Chrome



Black



Bronze



Satin Nickel



Satin Chrome

CODE	DESCRIPTION	PRICE
SHC-PB-RE or SQ	1 ³ / ₄ " Ball Bearing Pulley (Radius or Sqaure)	£8.19
SHC-2-PB-RE or SQ	2" Ball Bearing Pulley (Radius or Sqaure)	£12.33

Ball Bearing Pulleys

High-Quality Ball Bearing Axle Pulley with concealed faceplate rivets.

- Radius or Square end available
- Max weight 50kg
- Comes with screws
- Ball-bearing wheel for smooth movement of sash
- Same routing preparation every time

SP-PB-SQ
SP-PB-RE

ANY FINISH
£3.40

PLEASE STATE IF YOU REQUIRE RADIUS OR SQUARE END



Finishes:

Polished Chrome
Polished Brass
Satin Chrome

Key Features:

- 13-4" Wheel
- 2 Face-Fixing Points

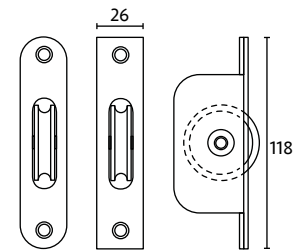

2" Pulleys

High-Quality Ball Bearing Axle Pulley with concealed faceplate rivets.

- Radius or Square end available
- Comes with screws
- Extra fixing holes
- Ball-bearing wheel for smooth movement of sash
- Rivetless face for a better look

SP-2-PB-SQ
SP-2-PB-RE

ANY FINISH
£7.16

PLEASE STATE IF YOU REQUIRE RADIUS OR SQUARE END



Finishes:

Satin Chrome
Polished Brass
Polished Chrome

Key Features:

- 2" Wheel
- 2 Face-Fixing Points (Radius)
- 4 Face-Fixing Points (Square)

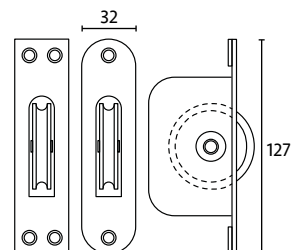

Budget Pulleys

Budget Axle Pulley with galvanised faceplate.

- Radius or Square end available
- Competitive Pulley
- Nylon Wheel

PUL-GLA-SQ
PUL-GLA-RE

£1.25
each

PLEASE STATE IF YOU REQUIRE RADIUS OR SQUARE END



Key Features:

- 13-4" Nylon Wheel
- 2 Face-Fixing Points

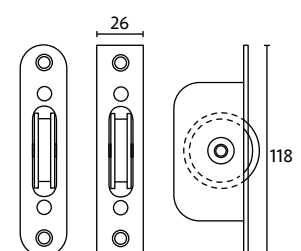



BETTER THAN THE REAL THING

This innovation from SDH with Qwood allows Joiners to be even more efficient in the assembly process due to the 'Clip-In' nature of this product.

This product is produced alongside the other Qwood beads, allowing for reduced labour time, little or no movement, and requiring only one topcoat.

The Qwood range of profiles, has become the leading timber composite beading product in the UK.

'Clip-In' Qwood benefits from the following;

- 'CLIP-IN' PARTING & STAFF BEAD
- NO PINNING, FILLING, SMOOTHING OR, REPAINTING
- EASY REMOVAL OF SASHES
- SAME CLIP GROOVE FOR PARTING AND STAFF BEAD
- ONE TOP COAT FOR A FANTASTIC DURABLE FINISH
- NO END GRAIN SEALING



PROCESS FOR RUNNING TIMBER BEADS



QWOOD PROCESS

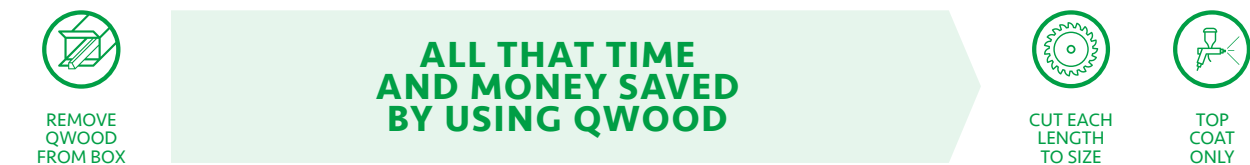

SDH CONTINUE TO INVEST IN **NEW QWOOD** PROFILES AND EXTEND OUR EXCLUSIVE RANGE

Why use Qwood?

- Used by joiners for over 10 years
- Over 10 million metres fitted
- Only FSC/PEFC certified product of its type, with 25% wood content
- More profiles than any other system on the market
- 7 of the top 10 UK joineries use it
- Does not rot
- Consistently straight
- No sanding or pre paint preparation
- No pinning on clip bead profiles
- Minimal Expansion or Contraction



Qwood is the **ONLY** composite beading product available on the market that is **FSC certified**

Please Note: Section drawings are just examples and not a specification.

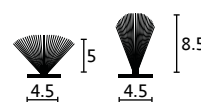

Slide Pile

PS6 £14.04 Per 100m
PS7 £22.51 Per 100m



'T' Slot

PS60 80p Per metre

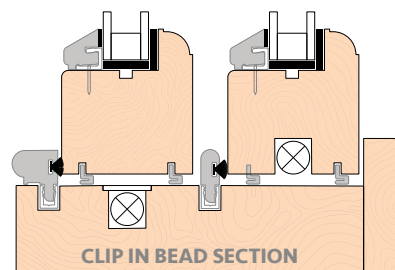

7mm Parting Bead	8mm Parting Bead	20x15mm Staff Bead	25x15mm Staff Bead	8mm Parting Bead	20x15mm Staff Bead	8x10mm Staff & Parting Bead Clip
£6.10	£6.08	£7.38	£9.60	£7.10	£9.17	£3.24

STAFF & PARTING BEADS (NO IMPLY)

8x25mm Parting Bead	20x15mm Staff Bead	7mm Parting Bead
£5.90	£7.49	£7.10

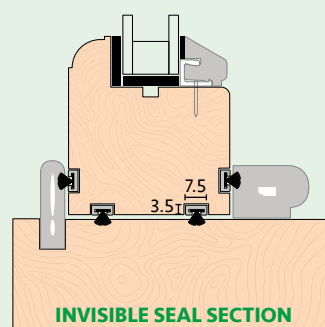

It's increasingly popular for Joiners to manufacture sash windows with the brush pile fitted to the sash rather than the staff and parting beads. This creates a much cleaner and more traditional look, by hiding the brush pile from sight.

ALL PRICES PER 3M LENGTH

20-25 x 15mm Timber Staff Bead (3m)

- Primed
- Includes carrier
- Please see **page 11** for suitable pile

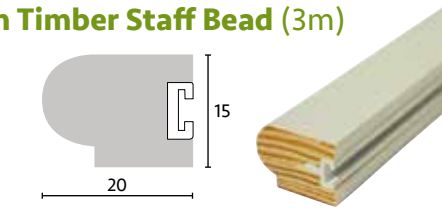

PSB20X15 or PSB25X15

from **£5.52** per 3m length

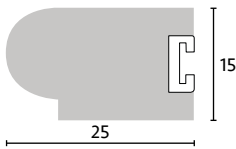

24 x 20 ALSO AVAILABLE ASK FOR DETAILS
FSC

Staff Bead with Pile Carrier

- Primed
- 3 metres
- Includes carrier and 6.5mm pile

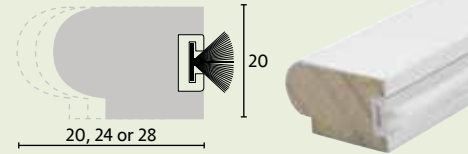

20x20mm **PSB20X20-PI**
£7.30 per 3m length

20x24mm **PSB20X24-PI**
£8.02 per 3m length

20x28mm **PSB20X28-PI**
£9.31 per 3m length

7-8 x 25mm Timber Parting Bead (3m)

- Primed
- Includes carrier
- Please see **page 11** for suitable pile

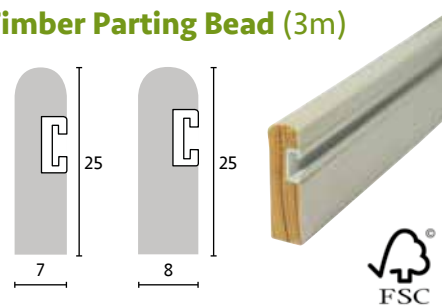

PPB7X25 or PPB8X25

from **£5.11** per 3m length

FSC

Parting Bead with Pile Carrier

- Primed
- 3 metres
- Includes carrier and 6.5mm pile

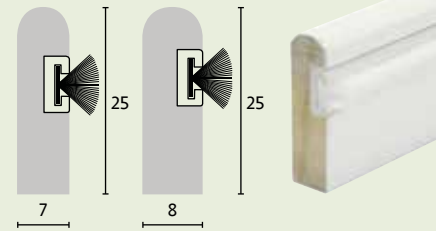

PPB(7or8)x25-PI
from **£6.14** per 3m length

OTHER SIZES AND UNPRIMED OPTIONS AVAILABLE, PLEASE ENQUIRE WITH OUR SALES TEAM

Parting Bead with Brush or 'T' Slot (3m)

- Cut in half for hidden weather seal
- Priced per 3m length
- Smooth sash movement
- Available in Brown & White

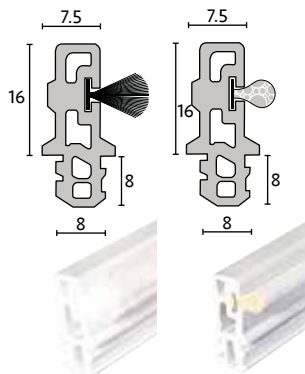

PPBB-W
£7.16

PPBT-W
£8.43

Parting Bead Flipper (3m)

- Highly effective bead
- Easy fitting
- Twin co-extruded flipper
- Available in Brown & White

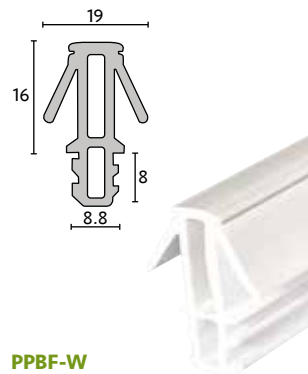

PPBF-W
£7.16 per length

Sliding Sash Flipper Weatherseal (96m coil)

NEW

- Rigid Back – ensures an easy mounting process
- Designed to be concealed from view, providing a traditional look to the window
- Available in Black or White

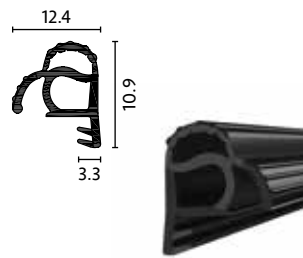

DEV-SP5920-B/W
£132.51 per 96m coil

DEVENTER

Q-Lon Weatherseal (250m coil)

- High durability, superior recovery performance
- Weather and UV resistant
- Glass fibre thread or polypropylene insert
- Smooth or embossed exterior, resistant to contamination
- Seals gaps of 2.5mm - 7mm
- Available in Black & White

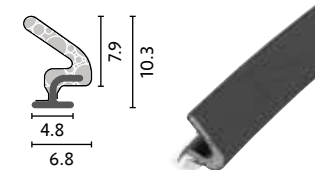

QL48800-B/W
£130.10 per 250m coil

Schlegel

Retaining Profile

- 3m lengths
- For parting bead above (PPBB-PPBT)
- Makes moving & replacing sashes easier



PPRP-W
£2.01 per length

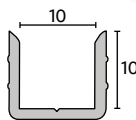

Perimeter Seal

- 3m lengths
- Excellent slide seal
- Available in Brown & White



PSS-W
£1.73 per length

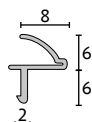

Plastic Staff Seal

- 2.4m in length
- Designed to fit a 2.5mm wide x 5mm deep groove
- Seal gap up to 5.5mm



PS70-W
£4.80 per length



NEW

Self Adhesive Carriers

- 2.2m lengths
- Easy fit
- Fantastic perimeter seal

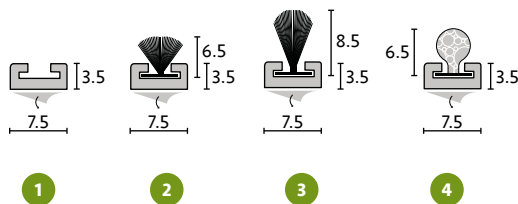

Each profile is available in Brown or White

#	CODE	DESCRIPTION	PRICE
1	PS1	Self Adhesive Carrier (use with PS6, PS7, PS60 or PS61)	77p
2	PS4	Self Adhesive Carrier with 6.5mm Pile	£1.12
3	PS8	Self Adhesive Carrier with 8.5mm Pile	£1.32
4	PS9	Self Adhesive Carrier with 6.5mm 'T' Slot	£2.96

Centre Leg Carriers

- 2.2m lengths
- Easy fit
- Strong retention due to spurs on legs

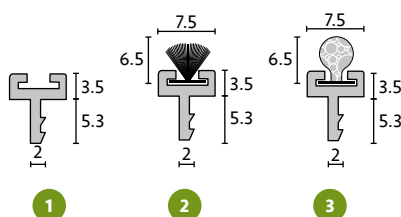

Each profile is available in Brown or White

#	CODE	DESCRIPTION	PRICE
1	PS19	Centre Leg Carrier (use with PS6, PS7, PS60 or PS61)	77p
2	PS2	Centre Leg Carrier with 6.5mm Pile	£1.12
3	PS11	Centre Leg Carrier with 6.5mm 'T' Slot	£2.96

Offset Leg Carrier

- 2.2m lengths
- Easy fit
- Strong retention due to spurs on legs

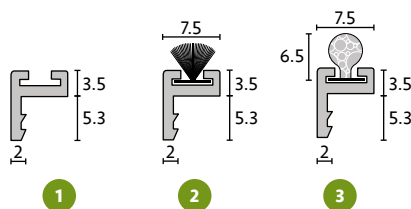

Each profile is available in Brown or White

#	CODE	DESCRIPTION	PRICE
1	PS12	Offset Leg Carrier (use with PS6, PS7, PS60 or PS61)	77p
2	PS3	Offset Leg Carrier with 6.5mm Pile	£1.12
3	PS13	Offset Leg Carrier with 6.5mm 'T' Slot	£5.34

Pile and 'T' Slot

- Easy fit
- Pile includes centre fin for improved weatherseal

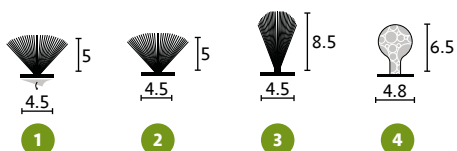

Each profile is available in Brown or White

#	CODE	DESCRIPTION	PRICE
1	PS20	5mm Self Adhesive Pile (sold in 100m)	£24.60
2	PS6	5mm Slide Pile (sold in 100m)	£14.04
3	PS7	8.5mm Slide Pile (sold in 100m)	£22.51
4	PS60	6.5mm 'T' Slot (sold per metre)	80p

PS1

PS4 & PS8

PS9

PS19

PS2

PS11

PS12

PS3

PS13

PS20

PS6

PS7

PS60

BEST SELLER

ERA

Spiral Balances

Spiral Balance windows are the modern version of a traditional double-hung timber sliding sash window. The double-glazed sashes slide by means of modern pre-tensioned springs instead of pulleys and weights. Traditional sash windows have a reputation for rattling, jamming, and draughts that affect their installation and operation. Spiral balances can help eliminate these problems and make the window more efficient and easier to operate.

FEATURES

- Easily adjustable (using a flexible screwdriver)
- Stainless steel springs
- Tested to over 25,000 cycles
- White tubes as standard but can come in following colours: Cream, Brown, Tan, Black and Grey.
- Mechanical guarantee
- Weight range from 5lbs -110lbs

FULL FITTING INSTRUCTIONS AVAILABLE

SDH highly recommend using pretension balances; not only do these come with a lifetime homeowner guarantee, they are so much easier for the end-user to operate. For that little bit extra in cost you get a far better product and a more efficient window.



Joinery by: Stanbrook & Nicholson

WHY USE THESE BALANCES?

- Manufactured in the UK
- A brand you can trust with over 40 years of supplying balances
- Very quick turnaround from order to delivery
- They have been used on a test to achieve PAS 24 security test

Flex Adjustment Tool

FLEX-ADJ-COMBI

£5.18
each



Metal Adjustment Tool

FKINSTOOL

£5.31
each

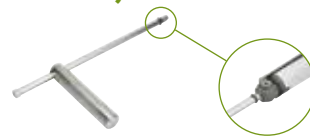

D BALANCE

PLEASE FILL OUT SPIRAL BALANCE FORM OPPOSITE AND ENQUIRE FOR PRICES

3 easy steps to ordering balances

1. Photocopy spiral balance form on next page or download from sdhardware.co.uk/resources/forms or scan QR code
2. Fill out form following the example (example shown in grey, on the right hand side of the form)
3. Email the form to sales@sdhardware.co.uk



SCAN TO
DOWNLOAD
FORM

Once you have sent us the form, we will get back to you with a quote. Usually within an hour or two. If you're happy to go ahead your balances will then be sent directly to you within 3-5 working days.

**If circular head on top sash,
please contact our sales team**

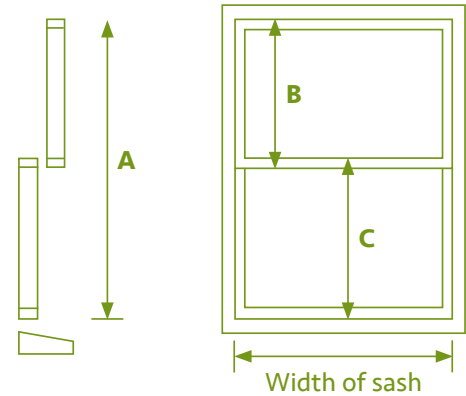

ORDER: (X)				COMPANY:		
ORDER NO:				ACCOUNT NO:		
CUSTOMER REF:				ADDRESS:		
ORDER DATE:				TEL - FAX:		
REQ DATE:				EMAIL:		
Additional Notes:						
BALANCE TUBE COLOUR						
PLEASE SPECIFY (X) (W=White, G=Grey, R=Brown, C=Cream, T=Tan)	W	G	R	B	C	T
TIMBER WINDOW SYSTEM (eg. NORMAL, TILT or EASYTILT)						NORM
WINDOW REF						EXAMPLE W1
WINDOW QUANTITY						1
PRETENSION ONLY (Y-N) (eg. F & K type only)						Y
DIMENSION 'A' - Height of sash run (must be less than B + C)						1000
DIMENSION 'B' - Height of top sash (excluding horns)						520
LENGTH OF TOP SASH HORNS						50
DIMENSION 'C' - Height of bottom sash (excluding horn)						520
LENGTH OF BOTTOM SASH HORNS						50
SASH WIDTH						
GLAZED WEIGHTS (kg)	TOP					15
	BOTTOM					15
GLAZING SPECIFICATION (eg. 4-18-4 - full spec req)						
SIDE FIX BOTH SASHES (Y-N)						Y
NOTE: ON ARCH HEAD VS WINDOWS PLEASE SEND COMPLETE DRAWING WITH, WE MUST BE NOTIFIED OF NON STANDARD WINDOW SPECIFICATIONS (i.e. high density timber materials & slim horn depth dimensions below 47mm if grooving in sash frame)						
IF ACCURATE GLAZED WEIGHTS AREN'T PROVIDED WE CANNOT ACCEPT RESPONSIBILITY FOR INCORRECT SUPPLY OF BALANCES. T&C's APPLY						
TOOLS (X)						
BE-WIR-22498	D Type Adj Tool					
FKINSTOOL	F & K Fitting Tool					
FLEX-ADJ-TOOL	Flexi Adjustment Tool					

EXAMPLE SHOWN HERE

Fitch Fastener

- Available in locking (SSF1) and non-locking (SSF3)
- Traditional sash fastener
- Narrow 13mm keep
- Complete with screws
- Available in Polished Brass, Polished Chrome & Satin Chrome



SSF1

LOCKING
£3.06

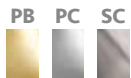

SSF3

NON-LOCKING
£2.96

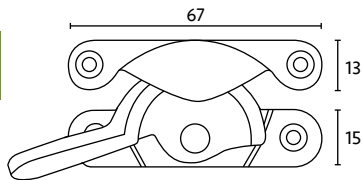

SDH Modern Cam Catch

- Key locking modern cam catch
- Slim keep
- Also available in Black, ask for details



Catch & Keep
SSF22

£7.92
each

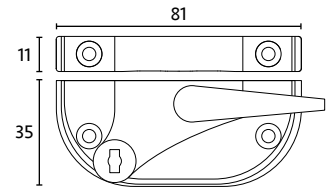

Locking Claw Fastener

- A decorative alternative to fitch fasteners
- Complete with screws
- Narrow 10mm back plate
- Available in Polished Brass, Polished Chrome & Satin Chrome
- Also available in Black, ask for details



SSF4

ANY FINISH
£4.02

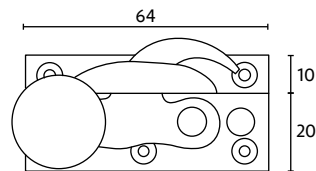
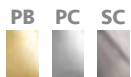

Brighton Fastener

- Non-locking
- Great for compressing mid-rail
- Complete with screws
- Available in Polished Brass, Polished Chrome & Satin Chrome



SSF2

ANY FINISH
£4.17

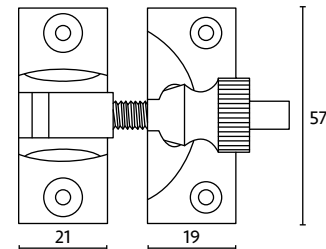
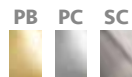

Quadrant Arm Fastener

- Modern sash fastener is crafted in polished brass
- Complete with screws



SSF8

ANY FINISH
£3.99

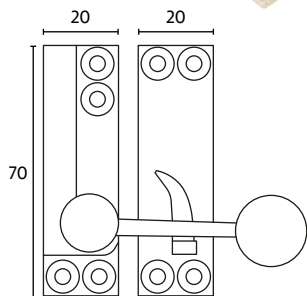
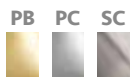

Narrow Brighton Fastener

- Narrow 13mm back plate
- Ideal for double glazed sashes
- Complete with screws



Non-Locking
SSF9

£4.09
each

Locking
SSF12

£5.33
each

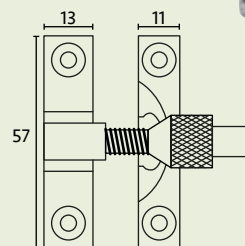

ALL PRODUCTS ON THIS PAGE ARE ALSO AVAILABLE IN A RANGE OF OTHER FINISHES

Sash Lift

- Solid Brass die cast
- Complete with screws
- 50mm width
- Available in Polished Brass, Polished Chrome & Satin Chrome



SSF6

ANY FINISH
£1.24

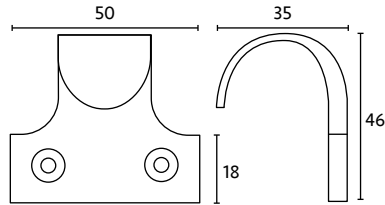
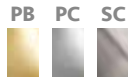

Sash Ring

- Decorative Sash Ring
- Complete with screws
- Available in Polished Brass, Polished Chrome & Satin Chrome



SSF7

ANY FINISH
£1.07

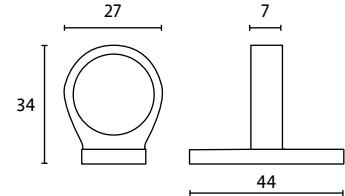
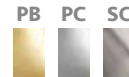

D Handle

- Decorative D handle to fit on bottom of top sash
- 127mm in length
- Complete with screws
- Available in Polished Brass, Polished Chrome & Satin Chrome



SSF5

ANY FINISH
£1.07

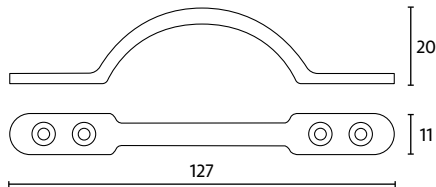
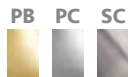

Twist Lock

- Ideal for restricting or venting a sliding sash window
- Complete with screws



SSA-TL

£5.37
each

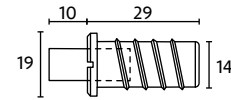
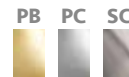

ALSO AVAILABLE IN ANTIQUE BRASS & BRONZE
PRICE ON APPLICATION

Weekes Sash Stop

- No key required
- Complete with screws
- Auto restricts sash



SF10

£2.76
each

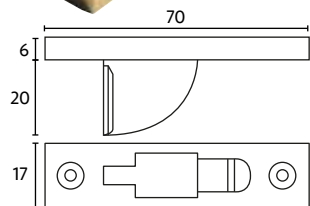
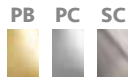

Sash Cord Plug

- Sash Cord Plug to attach cord to the sash
- Complete with screws
- Tidy and secure



SSA-CP

£2.63
each

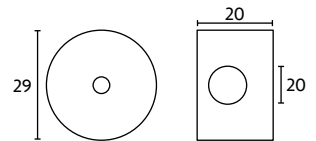
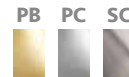

26mm Roller Stop

- 26mm Roller Stop
- Complete with Key
- Polished Brass, Polished Chrome or Satin Chrome

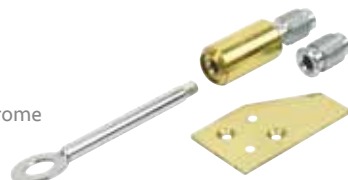

SSA-SS26

£4.76
per pack

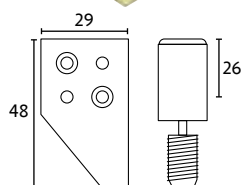
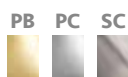

19mm Roller Stop

- 19mm heavy duty Sash Stop
- Includes: 1 x Stop, 2 x Receivers, Key & Plate
- 2 Keeps for multi restricted positions



SSA-SS19

£3.99
each

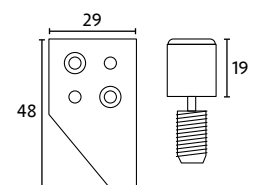

ALL PRODUCTS ON THIS PAGE ARE ALSO AVAILABLE IN A RANGE OF OTHER FINISHES

joinersforum[®]

JOIN THE COMMUNITY
www.joinersforum.com

Join the community and connect with other joiners in the industry.

SDH have invested in this community group in the hope that, in future it will be the go to place for Joiners to ask for advice and discuss with fellow joiners throughout the UK. Something we believe is only going to benefit the industry.



IDEAS & SUPPORT



ADVICE & CHAT



SHARE WORK

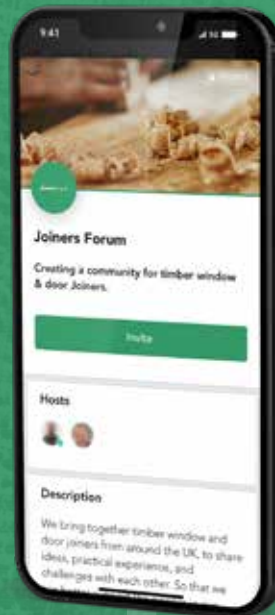

JOIN DISCUSSIONS ON

- The latest industry legislation
- How Part Q will affect joineries if introduced for refurbishment
- Running your own beading versus timber composite beading like Qwood
- Raw materials costs
- General discussions on running a business

and lots more...

Anything that is related to the manufacture of timber windows and doors and general business discussion are welcome. Also feel free to share work you're proud of or light hearted behind the scenes of being in the industry.

HOW TO JOIN

- Visit www.joinersforum.com or scan the QR code
- Request to join or sign in
- Download the Mighty Networks app to use on the go

SCAN TO SIGN UP AND LOGIN





SCAN TO
VIEW FULL
COLLECTION
ONLINE

OVER **560** PRODUCTS IN THIS RANGE



Handcrafted Style & Sophistication

Add that finishing touch to your (restored or brand new) windows with our collection of **hand crafted** solid brass sliding sash furniture.

Available in a large array of finishes & styles, this range of fasteners and decorative sash hardware will enhance any sliding sash window or interior style.



SASH HERITAGE[®]

COLLECTION

A SELECTION OF THIS RANGE IS AVAILABLE ON THE NEXT FEW PAGES...
FOR THE FULL COLLECTION VISIT

sdhardware.co.uk/brands/sash-heritage

1 SHC185 or SHC185L
Narrow Brighton Fastener
 • Size of Plate: 56mm x 13mm
 • Height of Product: 63mm
 • Complete with screws
Non-Locking
 from **£6.77 each**
Locking
 from **£11.52 each**

2 SHC161 or SHC161L
Brighton Fastener
 • Size of Plate: 59mm x 21mm
 • Height of Product: 65mm
 • Complete with screws
Non-Locking
 from **£7.35 each**
Locking
 from **£14.49 each**

3 SHC097
Straight Arm Fastener with Plain Round Knob
 • Size of Plate: 65mm x 20mm
 • Height of Product: 30mm
 • Complete with screws
 from **£14.36 each**

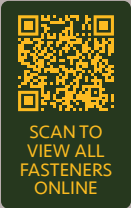

SASH FASTENERS

This comprehensive collection of Sash Window Fasteners features a wide variety of styles to suit a range of Sash Window styles.

This range of fasteners have been designed with the end-user in mind, providing a practical and easy-to-use solution to securing your sash windows while adding a beautiful, elegant finish to match your home decor.

MORE STYLES AND TECHNICAL DRAWINGS AVAILABLE ONLINE

4 SHC158
Non-Locking Quadrant Fastener
 • Size of Plate: 65mm x 20mm
 • Height of Product: 35mm
 • Complete with screws
 from **£7.89 each**

5 SHC183 or SHC183L
Fitch Fastener
 • Size of Plate: 67mm x 16mm
 • Height of Product: 22mm
 • Complete with screws
Non-Locking
 from **£6.97 each**
Locking
 from **£7.87 each**

6 SHC107 or SHC107L
Brighton Acorn Fastener
 • Size of Plate: 48mm x 22mm
 • Height of Product: 65mm
 • Complete with screws
Non-Locking
 from **£14.49 each**
Locking
 from **£17.87 each**



CLAW FASTENERS

Beautifully hand crafted using solid brass, these claw sash fasteners are a decorative alternative to Fitch Fasteners. Featuring detailed and decorative knobs.

FINISHES*



MORE STYLES AND TECHNICAL DRAWINGS AVAILABLE ONLINE

*SOME PRODUCTS MAY NOT BE AVAILABLE IN ALL FINISHES. PLEASE CHECK ONLINE OR WHEN PLACING ORDERS.



SCAN TO VIEW ALL FASTENERS ONLINE

BEST SELLER

NEW

- 1** SHC108WR or SHC108WRL
Claw Fastener with Black or Rosewood Knob
- Size of Plate: 65mm x 19mm
 - Size of the Keep: 65mm x 9mm
 - Height of Product: 48mm

Non-Locking
from **£16.40 each**
Locking
from **£18.11 each**

- 2** SHC108 or SHC108L
Claw Fastener with White or Black Ceramic Knob
- Size of Plate: 65mm x 19mm
 - Size of the Keep: 65mm x 9mm
 - Height of Product: 48mm

Non-Locking
from **£13.84 each**
Locking
from **£15.20 each**

- 3** SHC113 or SHC113L
Claw Fastener with Reeded Knob
- Size of Plate: 65mm x 19mm
 - Height of Product: 35mm

Non-Locking
from **£12.26 each**
Locking
from **£13.80 each**

- 4** SHC197 or SHC197L
Claw Fastener with Ball Knob
- Size of Plate: 64mm x 18mm
 - Size of the Keep: 63mm x 10mm
 - Height of Product: 35mm

Non-Locking
from **£9.14 each**
Locking
from **£11.04 each**

- 5** SHC079 or SHC079L
Claw Fastener with Knurled Knob
- Size of Plate: 65mm x 19mm
 - Size of the Keep: 64mm x 10mm
 - Height of Product: 30mm

Non-Locking
from **£11.28 each**
Locking
from **£14.18 each**

- 6** SHC106
Art Nouveau Claw Fastener
- Size of Plate: 66mm x 20mm
 - Non-Locking only

from **£13.66 each**

SASH LIFTS & EYES

Our cohesive collection of Sash Lifts & Eyes features a selection of styles to suit many Sash Windows. This range of beautifully handcrafted Sash Lifts & Eyes have been designed to provide a practical and easy-to-use solution to opening sash windows while adding a beautiful, elegant finish to match your home decor.

FINISHES*



MORE STYLES AND TECHNICAL DRAWINGS AVAILABLE ONLINE



*SOME PRODUCTS MAY NOT BE AVAILABLE IN ALL FINISHES. PLEASE CHECK ONLINE OR WHEN PLACING ORDERS.

1 SHC187
Sash Eye
 • Size of Plate: 43mm x 17mm
 • Height of Product: 33mm
 • Comes with Screws

from **£2.84 each**

2 SHC205
Sash Eye
 • Size of Plate: 37mm x 16mm
 • Height of Product: 30mm
 • Comes with Screws

from **£2.84 each**

3 SHC186
Sash Eye
 • Size of Plate: 50mm x 18mm
 • Height of Product: 37mm
 • Comes with Screws

from **£4.05 each**

4 SHC167
Reeded Sash Lift
 • Size of Plate: 45mm x 38mm
 • Height of Product: 28mm
 • Comes with Screws

from **£2.84 each**

5 SHC164
Sash Lift
 • Size of Plate: 50mm x 45mm
 • Height of Product: 35mm
 • Comes with Screws

from **£3.03 each**

6 SHC166
Sash Lift with Full Border
 • Size of Plate: 50mm x 45mm
 • Height of Product: 37mm
 • Complete with screws

from **£4.05 each**

MORE STYLES AND TECHNICAL DRAWINGS AVAILABLE ONLINE

SASH HANDLES

These Sash Handles are a conventional and easy-to-use sash handle for moving sash windows up and down. What's great about these handles is the range of matching finishes available as part of the Sash Heritage Collection.

FINISHES*



*SOME PRODUCTS MAY NOT BE AVAILABLE IN ALL FINISHES. PLEASE CHECK ONLINE OR WHEN PLACING ORDERS.



1

SHC171

Sash Handle

- Size of Plate: 132mm x 12mm
- Height of Product: 23mm
- Comes with Screws

from **£3.03 each**

2

SHC153

Shaped Sash Handle

- Size of Plate: 129mm x 17mm
- Height of Product: 35mm
- Comes with Screws

from **£6.27 each**

3

SHC172

Sash Handle with Border

- Size of Plate: 136mm x 14mm
- Height of Product: 31mm
- Comes with Screws

from **£3.85 each**



**MORE DECORATIVE
STYLES AND TECHNICAL
DRAWINGS ARE
AVAILABLE ONLINE**



SECURITY & RESTRICTORS

These range of restrictors allow your sash window to be vented but not compromised on security. The restrictor element allows the sashes to be open only to a predetermined opening that will prevent the risk of children and the infirm from falling out of an open window

FINISHES*



MORE STYLES AND TECHNICAL DRAWINGS AVAILABLE ONLINE

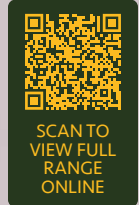

*SOME PRODUCTS MAY NOT BE AVAILABLE IN ALL FINISHES. PLEASE CHECK ONLINE OR WHEN PLACING ORDERS.

1 SHC193
Weekes Sash Stop
with Radius Ends

- Dimensions: 70 x 17 x 26mm
- No key required
- Complete with screws

from **£5.10 each**

2 SHC193S
Weekes Sash Stop
with Square Ends

- Dimensions: 70 x 17 x 26mm
- No key required
- Complete with screws

from **£5.10 each**

3 SHC256 (28mm) SHC195 (19mm)
Sash Stop

- Easy to install
- Includes 2 colour matched Stainless Steel inserts & key

28mm from **£13.28 each**
 19mm from **£8.15 each**

4 SHC181
Flush Lock Sash Stop
with Key

- Stop can be retracted into the barrel to allow the window to be fully opened

from **£11.73 each**

5 SHC200 (100mm) SHC198 (70mm)
Dual Screw *with Key*

- Midrail security screw to lock sash windows in to position
- Complete with key

100mm from **£11.05each**
 70mm from **£9.14 each**

6 SHC266
Bartholomew Sash Stop

- Fitted to the top Sash to restrict the bottom sash from passing

from **£5.22 each**

MORE STYLES AND TECHNICAL DRAWINGS AVAILABLE ONLINE

DRAUGHTSEALS COMING SOON!

HAPPY.
HELPFUL.
HONEST.



THE NEXT
CATALOGUE IN
OUR SERIES IS
PACKED WITH
DRAUGHTSEALS
AND RELATED
PRODUCTS FROM
TOP BRANDS IN
THE INDUSTRY.

SOME OF THE
BRANDS YOU'LL
FIND INSIDE...

DEVENTER



KEEP THINGS
TOGETHER,
WITH THE SDH
RING BINDER!

**FREE WITH
YOUR FIRST
ORDER OVER £500**

*ADDITIONAL BINDERS CAN BE PURCHASED ON REQUEST.



A LEADING
SUPPLIER OF
WINDOW & DOOR
HARDWARE TO THE
JOINERY INDUSTRY

ORDER BY **PHONE**, **EMAIL** or **WEB**



01752 651330



sales@sdhardware.co.uk



www.sdhardware.co.uk

SD Hardware Ltd | Unit 7 Forge Lane, Enterprise Park, Saltash, Cornwall PL12 6LX
Phone: 01752 651330 **Fax:** 01752 253823 **Email:** sales@sdhardware.co.uk

