

ERA TOUCHKEY

Live Smarter.

ERA TouchKey is a highly secure versatile keyless entry and exit solution, that uses multi-level authentication. It combines traditional mechanical door hardware with world-renowned smarter technology, offering a new way to access a home without needing a key.

- A complete security solution that includes the auto fire multi-point lock, smarter handle and anti-bump cylinder. With built-in security features across the whole system to reduce the risk of forced entry, the mechanical hardware and latest smarter technology work seamlessly together
- TouchKey can be used as a stand alone door security solution or as part of the wider ERA smart ecosystem. That includes smart alarms, video doorbell and cameras, providing consumers with an integrated smart home solution from one mobile app
- The removable communication module can be updated later if required (by the homeowner) supporting emerging technologies to integrate with other household devices as new technology and standards emerge
- Available in a choice of Hardex finishes to complement any home or décor. TouchKey perfectly matches over 200 products within the Fab&Fix range including hinges, letterplates and knockers



KM 778494

A versatile door security solution.

TouchKey is a multi-access stylish security solution with multiple individual entry methods, that offers consumers choice and convenience twinned with the highest security.



Smart Home App

Unlock the door with a single touch using the ERA smart home app. Integrate TouchKey with the wider ERA smart products to allow remote unlocking of the door via the alarm hub*. Assign digital ekeys to trusted friends and family through the app or grant times access for cleaners or tradesmen.



Fingerprint

Advanced fingerprint technology to grant instant access. Store up to 50 prints and each users fingerprint is named within the app for clarity.



Bluetooth

Geolocation technology provides auto unlocking capabilities based on the proximity of the smartphone to the door. Once within range, a trusted digital ekey allows access to the property without taking the smartphone out of a pocket. Home and away technology ensures that when at home, the door cannot be unlocked by someone else when you are within range.



Key override

For ultimate peace of mind, ERA TouchKey has a hidden key override.

When closing the door, a trigger engages and fires all six locking points including the central deadbolt, automatically securing the door. To release, from the outside simply use one of the smart entry functions or key override; and from inside use the extended thumbturn, for easy smooth egress without a key.

ERA

TOUCHKEY

Using the latest smart technology.

TouchKey is the first UK BSI Smart Residential Locking Device. Independently tested and accredited to give our customers the ultimate reassurance in TouchKey and the ERA cloud platform.

- With the ERA smart home app, a user has full permission to control and monitor who has access to the property and track the activity of who's entered and at what time
- All digital ekeys are created securely on ERA's cloud platform and not stored on the phone or handle, creating a two-factor authentication with ERA's server when anyone enters the property to prevent hacking
- Self-learning smart fingerprint technology establishing robust user recognition by learning and adapting the characteristics of an enrolled fingerprint template through valid verification over time
- TouchKey uses Bluetooth to communicate with a smartphone, rather than relying on a WiFi or data connection
- GDPR compliant platform hosted on a UK ERA-owned data server
- Compatible with Siri voice unlock
- All wiring is contained within the smarter handle with timely user push notifications when battery are running low



Ordering Details

TouchKey is ordered as a complete door security solution that includes the auto fire multi-point lock, smarter handle and anti-bump cylinder. **All door keeps must be ordered separately** (please see door lock data sheet for details). Each kit is supplied suitable for either a left or right hung door, please refer to the table below for the relevant part number. **All components (including the keeps) must be purchased and installed together to function correctly and to comply with the BSI Kitemark.**

Door Thickness	Handle Finish	Part No. Left Hand Door	Part No. Right Hand Door
44/48mm	Hardex Chrome	DTK48HC609LH45KIT	DTK48HC609RH45KIT
44/48mm	Hardex Graphite	DTK48GR609LH45KIT	DTK48GR609RH45KIT
54/56mm	Hardex Chrome	DTK56HC609LH45KIT	DTK56HC609RH45KIT
54/56mm	Hardex Graphite	DTK56GR609LH45KIT	DTK56GR609RH45KIT

Suitable for inward opening composite and timber doors only. If you are manufacturing doors 54/56mm thick or outward opening doors, please contact us for application details. Not suitable for fire door applications.

Technical Information

Fingerprint sensor:	508dpi (maximum standard fingerprint capacity 50)
Power Supply Battery:	CR123A x 4PCS (do not use rechargeable batteries)
Bluetooth Version:	5.0
Data Connection	WiFi/ 3G, 4G, 5G (WiFi/4G/5G recommended)
Smart Home App:	Android and Apple devices supported using current operating system version, and the previous version**
Communication Module:	868 MHz-FSK (ERA Protect Alarm hub compatible)
Operating Temperature:	-20°C ~ +50°C
Storage Temperature:	-20°C ~ +75°C
Operating Humidity:	RH10%~95%
Storage Humidity:	RH10%~95%
Composite/Timber doors:	44mm to 56mm thickness (subject to PAS 24 test)



Mechanical Hardware
Guarantee



Smart Security
Guarantee



KM 778494



Secure Connected Device (SCD)

**Requires additional TouchKey Communication Module and separate Smart Hub for remote unlocking.

**Please check with the smartphone provider for details on the current and previous operating system.



TouchKey Smarter Door Handle



Features

- Part of the TouchKey multi-access door security solution certified to the BSI Smart Residential Locking Device Kitemark. Working in conjunction with the TouchKey auto fire door lock and TouchKey anti-bump cylinder to provide the ultimate smart home solution
- Forged steel backplate and hardened plates on the handle offer grip and anti-drill protection to prevent an attacker removing the handle backplate to access the lock
- The anti-pull pin and fixing plate secures the spindle in place on the internal handle and prevents it from being removed from the handle
- Fitted with an anti-snap feature, the spindle will snap at a sacrificial snap line to prevent access to the gearbox, if an intruder tries to apply a load to rotate the spindle
- Within the handle is a robust clutch system and hardened channel in the internal backplate of the handle to protect the mechanism within
- An internal mounting bracket holds the handle in place even if screws are compromised, the handle remains secure
- Battery operated, all wiring is neatly contained within handle so there is no need for any additional wiring to the door or an electrician (CR123 batteries x 4, supplied)
- Easily to access battery compartment with the option of a smooth or quilted effect cover (both supplied)
- Fitted with an audible deterrent if anyone should tamper with the handle
- Available in a choice of Fab&Fix patented Hardex finishes to complement home and décor
- Supplied handed with two spindles to suit different door sizes
- Suitable for composite and timber doors
- M6 security screws



Internal Handle

Fab&Fix



Hardex
Chrome

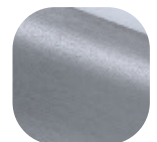

Hardex
Graphite



10
YEAR
Mechanical
Guarantee



Must be used in conjunction
with the TouchKey solution



Timber Composite



As part of a compliant
doorset



When fitted as part of the
complete TouchKey door solution



When fitted as part of the
complete TouchKey door solution

TouchKey Smarter Door Handle

Ordering Details

Ordering

The TouchKey handle is ordered as part of the complete TouchKey door access solution, please refer to the TouchKey data sheet for further information and part numbers.

Accessories

Description	Finish	Part No.
Cylinder Cover	Hardex Chrome	DTKCCHC
	Hardex Graphite	DTKCCGR
Internal Screw Cover	Hardex Chrome	DTKSCMBHC
	Hardex Graphite	DTKSCMBGR
Battery Cover	Smooth Black	DTKBCSTBL
	Quilted Black	DTKBCQUBL
Jig	N/A	DTKJIG

Technical Information

Corrosion resistance

Meets the requirements of BS EN 1670:2007 Grade 5 (480 hours)

Operation

Endurance tested in excess of 100,000 cycles

Performance

Tested to meet the requirements of PAS 24 as part of a compliant door set.

Timber doors:

44mm to 56mm thickness (subject to PAS 24 test)

Product Specification

Handle Grip and Backplate:	High quality Zinc for all Hardex finishes
Coatings:	Hardex Chrome, Hardex Graphite
Spindle / Screws:	Machine Bolts with Hex heads. 44mm - 48mm profiles (2x M6 X 52mm Bolts; 1x 8mm X 95mm Spindle). 54mm - 56mm profiles (2x M6 X 62mm Bolts; 1x 8mm X 105mm Spindle). For Mounting Bracket 2x ST3.2 X 13mm Pozi Screws
Cylinder:	TouchKey Euro Cylinder, 92mm PZ

Maintenance

For continued protection of the quality finish and appearance, Fab&Fix advise routine cleaning of all our external hardware. Moving parts should also be lightly lubricated at least twice a year. This procedure is particularly essential if products are used within a 25-mile radius of coastal areas or close proximity to building sites or large industrial areas, where more frequent cleaning may be required to prevent the accumulation of corrosive contaminants.

Packaging

1 per kit

The TouchKey door smart handle is sold as a complete kit, please refer to the TouchKey solutions data sheet for further information.

External Handle

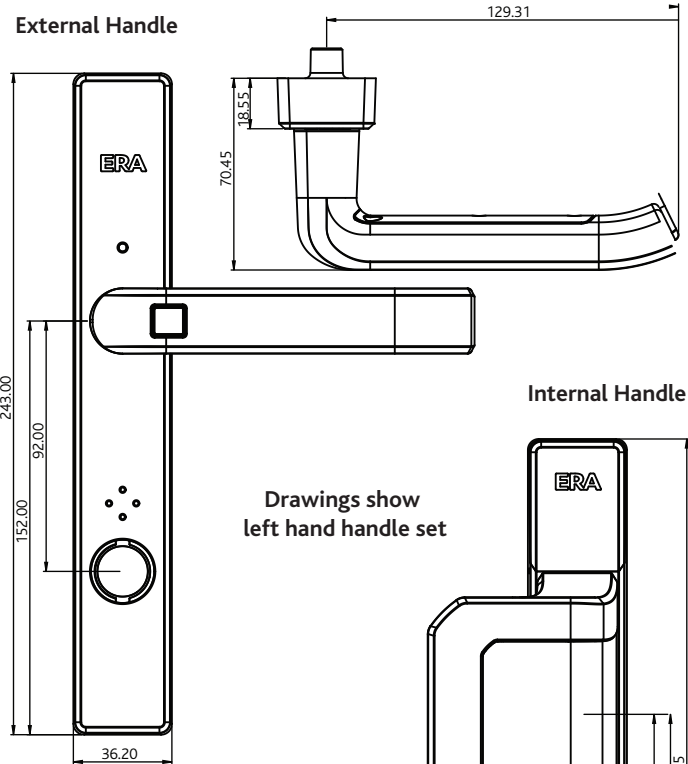

Internal Handle

Drawings show left hand handle set

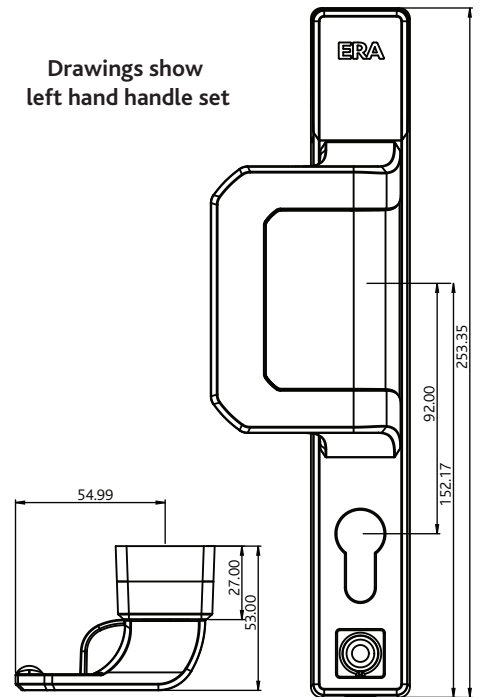

Not to scale. All dimensions are in mm and are nominal. ERA reserves the right to change specification without notice. It is the responsibility of the door manufacturer to ensure that the finished product meets any required safety and performance specification.

Handing Information

Handing is viewed from the outside of the door. Battery orientation is dependent on handing.

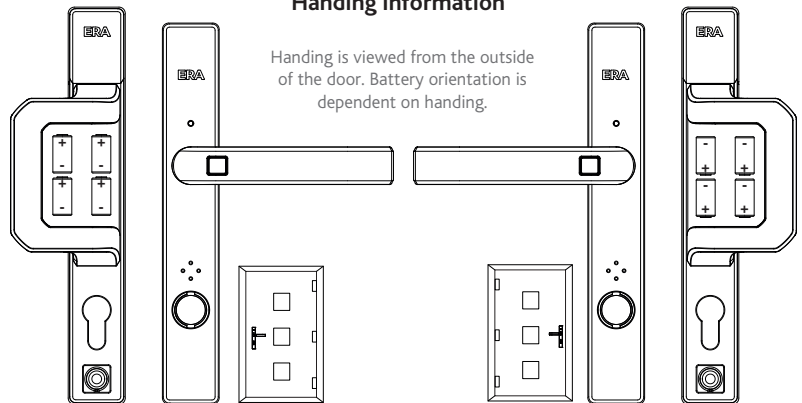

Left Hand Set

Right Hand Set

TouchKey 2 Hook Multi-Point Door Lock

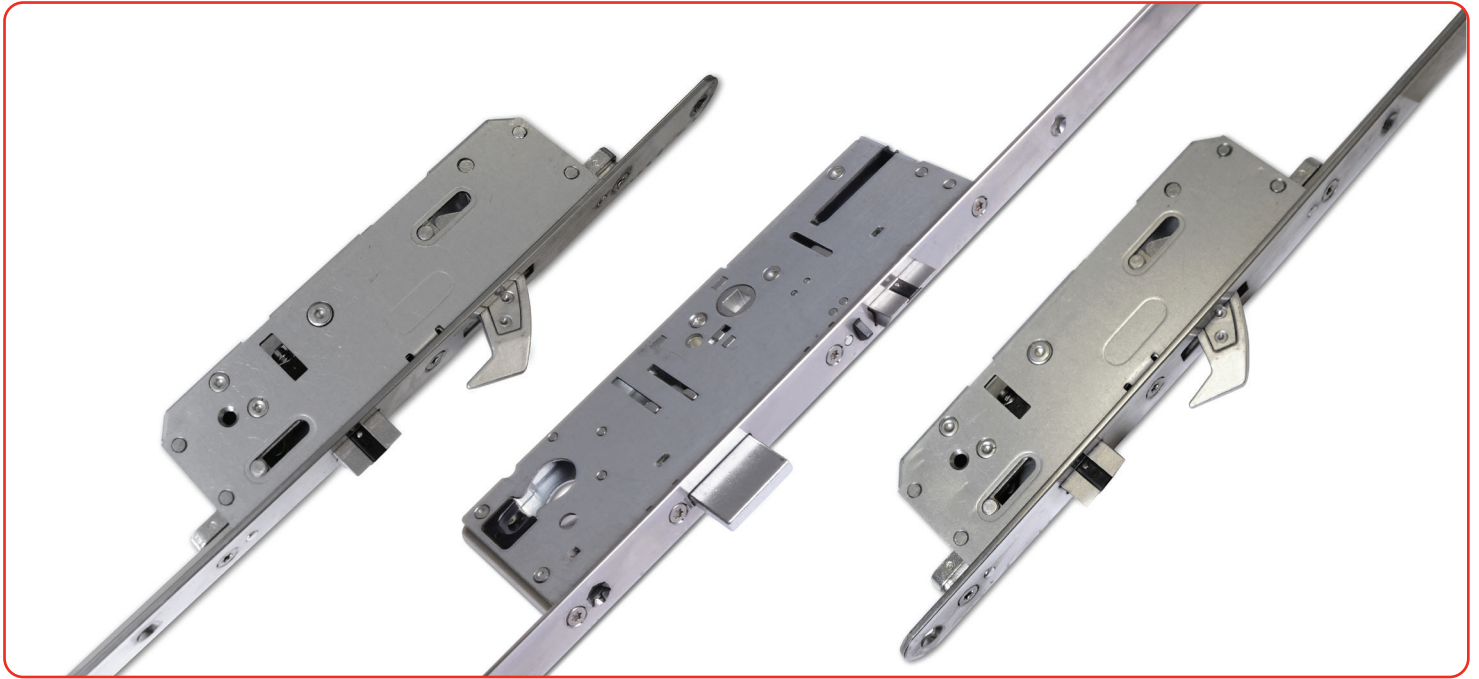

Features

- Part of the TouchKey multi-access door security solution certified to the BSI Smart Residential Locking Device Kitemark. Working in conjunction with the TouchKey smarter handle and TouchKey anti-bump cylinder to provide the ultimate smart home solution
- Shutting the door engages the trigger and fires all six locking points, including the central deadbolt into the keeps, automatically securing the door on closing. To release, simply use either one of the smart entry functions, external key override or internal thumbturn
- Unidirectional throw of hooks – enhanced anti-jemmy feature
- Twin tapered anti-jemmy hooks designed for high performance and security have anti-saw protection and hardened anti-drill inserts. Hooks will auto deadlock once activated for anti-separation resistance – 10mm (maximum) engagement into keep
- Manufactured from lightweight aluminium used within the aerospace industry, these hooks have been designed with lighter torque (0.8-1Nm) to ensure key operation is smooth and easy to turn
- Manufactured from injection moulded hardened Stainless Steel, the latch bolts have been designed to ensure the door is in the correct position before hooks engage into keeps and to prevent any side load pressure on the hooks during any normal lock operation
- Deadbolt throws 20mm to prevent unauthorised entry and has PTFE (plastic) lead to support low effort release
- Manufactured from Stainless Steel, the auto fire trigger is angled in a non-handed positioned below the latch bolt
- Steel reversible pull and twist or rear screw driver push and turn latch bolts for a non-handed lock mechanism
- Available as 45mm backset with a 20mm face bar
- Designed to meet the requirements of PAS 24 as part of a compliant door system and BS 6375
- Suitable for composite and timber doors, keeps to suit 44mm - 48mm timber and composite doors

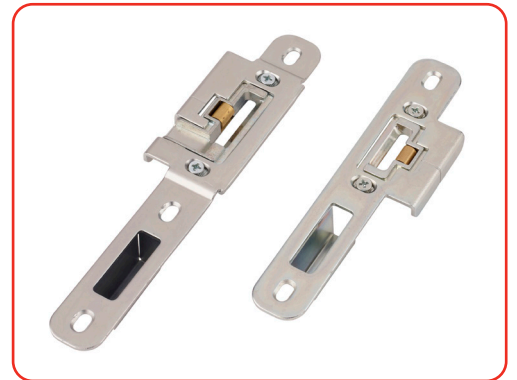

Keeps



10 YEAR
Mechanical
Guarantee



Must be used in conjunction with the TouchKey solution



Timber Composite



As part of a compliant doorset



When fitted as part of the complete TouchKey door solution



When fitted as part of the complete TouchKey door solution

TouchKey 2 Hook Multi-Point Door Lock

Ordering Details

KEY

To select the required 2 hook MPL part number, use the below to determine:

B Backset	OL Overall Length
FB Face Bar	TH Top Hook
DL Datum Line	BH Bottom Hook

- The face bar and backset
- The overall length of the unit
- The position of the hooks

B	FB	DL	OL	TH	BH
45	20	977	2137	715	680

Ordering

The TouchKey door lock is ordered as part of the complete TouchKey door access solution, please refer to the TouchKey data sheet for further information and part numbers. **All keeps will need to be ordered separately.** Please see below tables for details. If you are manufacturing doors 54/56mm thick, please contact us for part number and application details.

Keeps (must be ordered in addition to TouchKey kit)

Description	Size	Left Hand	Right Hand
Centre Keep (cranked)	44mm	DKSFCKL23487	DKSFCKR23488
Centre Keep (flat)	44mm	DKSFCKL31738	DKSFCKR31737
Centre Keep (cranked)	48mm	DKSFCKL24272	DKSFCKR24271
Centre Keep (flat)	48mm	DKSFCKL31877	DKSFCKR31876
Hook Keep (cranked)	44mm	DKSFHKL23489	DKSFHKR23490
Hook Keep (flat)	44mm	DKSFHKL31739	DKSFHKR31740
Hook Keep (cranked)	48mm	DKSFHKL24274	DKSFHKR24273
Hook Keep (flat)	48mm	DKSFHKL31878	DKSFHKR31879

Technical Information

Corrosion resistance

Meets the requirements of BS EN 1670:2007 Grade 4 (240 hours)

Operation

Endurance tested in excess of 150,000 cycles

Performance

Tested to meet the requirements of PAS 24 as part of a compliant door set.

Timber doors:

44mm to 56mm thickness (subject to PAS 24 test)

Material Specification

Lock case:	BZP CR3 Passivate + Seal
Face bar:	Stainless Steel 430
Hooks:	Aluminium anodised 2A50-T6
Deadbolt:	Zinc CR3 Passivate + Seal, PTFE insert
Latch Bolts:	Stainless Steel 304
Trigger:	Stainless Steel
Keeps:	Zinc with Brass roller

Maintenance

All moving parts should be lightly lubricated using a light non-acidic mineral oil (e.g. "3 in 1") twice per year and the surface cleaned with a soft damp cloth. The product may need to be adjusted and fixings tightened to ensure a satisfactory operation.

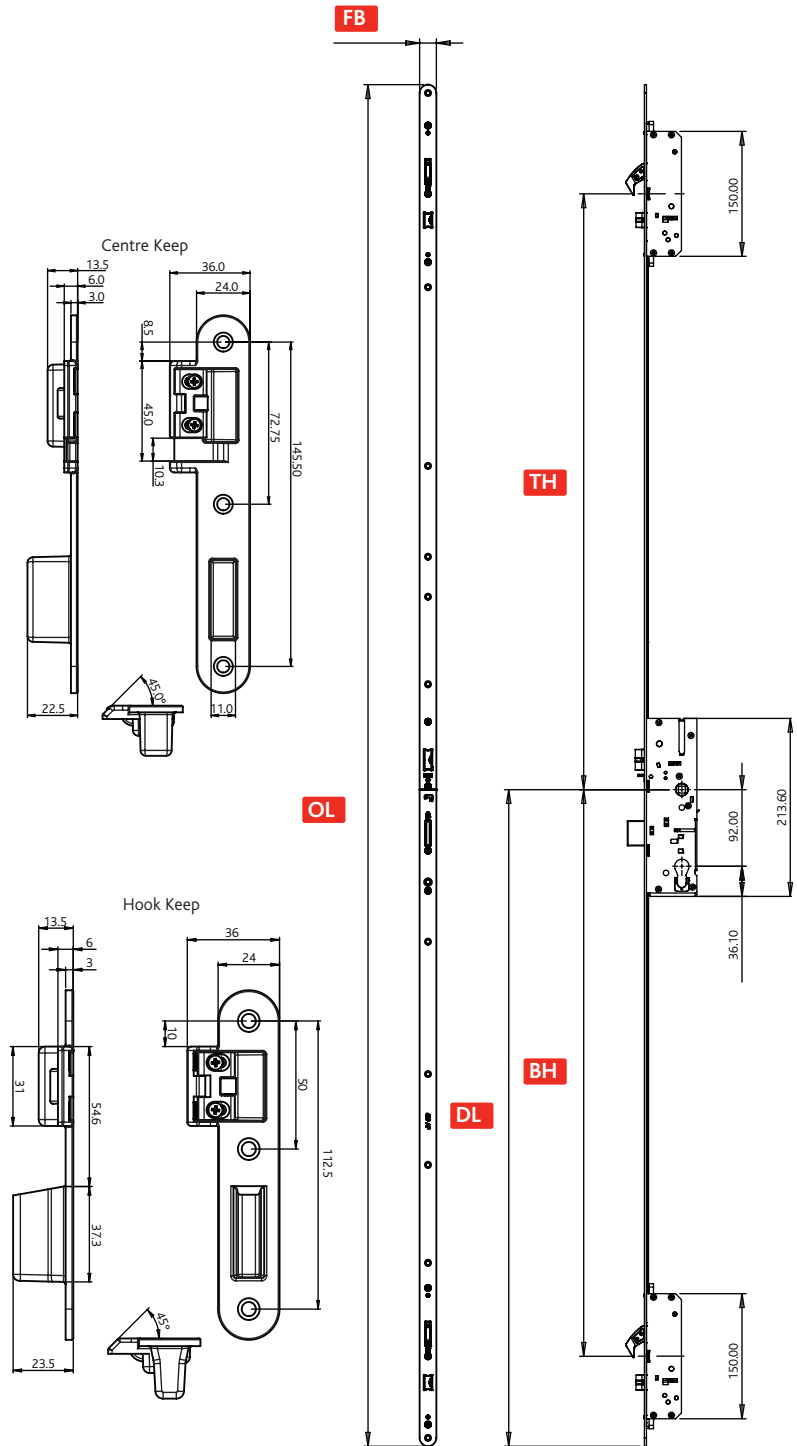

Diagram illustrates product in locked position. Not to scale. All dimensions are in mm and are nominal. ERA reserves the right to change specification without notice. It is the responsibility of the door manufacturer to ensure that the finished product meets any required safety and performance specification.

Packaging

1 per kit

The TouchKey door lock is sold as a complete kit, please refer to the TouchKey solutions data sheet for further information.

TouchKey Anti-Bump Cylinder



Features

- Part of the TouchKey multi-access door security solution certified to the BSI Smart Residential Locking Device Kitemark. Working in conjunction with the TouchKey Smarter Handle and TouchKey multi-point lock to provide the ultimate smart home solution
- High performance euro profile locking cylinder guaranteed for ease of application and long term trouble free performance
- Designed with 6 pin 'bumping' resistance security, the anti pick, anti plug and anti drill features means the cylinder offers excellent resistance to forced entry
- The large ergonomically designed extended thumbturn is shaped for comfort. The light torque ensures that the cylinder is easy to operate and smoothly turns retracting all locking hooks and the deadbolt simultaneously
- One turn exit with a simple thumbturn action and the door automatically locks behind you.
- Independently tested to meet the latest British Standards BS EN 1303:2005 for security
- Meets the requirements of PAS 24 as part of a compliant doorset
- Hardened pins for drill resistance
- 100,000 differs
- Available in a choice of Fab&Fix patented Hardex finishes to complement your home and décor
- Each cylinder is supplied with 3 keys
- Suitable for composite and timber doors



Must be used in conjunction with the TouchKey solution

As part of a compliant doorset

When fitted as part of the complete TouchKey door solution

When fitted as part of the complete TouchKey door solution

When fitted as part of the complete TouchKey door solution

When fitted as part of the complete TouchKey door solution

TouchKey Anti-Bump Cylinder

Ordering Details

Ordering

The TouchKey cylinder is ordered as part of the complete TouchKey door access solution, please refer to the TouchKey data sheet for further information and part numbers.

Accessories

If a TouchKey cylinder needs to be changed, it **MUST** be replaced by an official ERA TouchKey cylinder, it cannot be replaced with a standard euro cylinder.

Finish	Part No. Left Hand	Part No. Right Hand
Hardex Chrome 44/48	DCTK5035HCLH	DCTK5035HCRH
Hardex Graphite 44/48	DCTK5035GRLH	DCTK5035GRRH
Hardex Chrome 54/56	DCTK5540HCLH	DCTK5540HCRH
Hardex Graphite 54/56	DCTK5540GRLH	DCTK5540GRRH

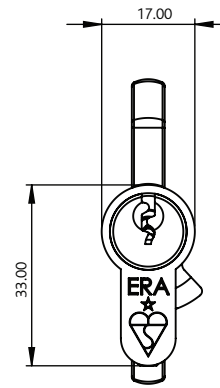

Technical Information

Corrosion resistance

Meets the requirements of BS EN 1670:2007 Grade 3

Operation

Endurance tested in excess of 100,000 cycles

Performance

Independently tested to meet the requirements of BS EN 1303:2015. Designed to meet the requirements of PAS 24 in a compliant door set. Must be used in conjunction with the TouchKey door access solution.

Timber doors:

44mm to 56mm thickness (subject to PAS 24 test)

Material Specification

Cylinder:	Brass
Cam:	Sintered Steel
Pins:	6 Hardened pins, anti bump anti pick, anti-drill
Key:	Nickel plated brass
Screw:	M5 x 50mm and M5 x 60mm nickel plates or polished brass screw
Finish:	Hardex Chrome, Hardex Graphite

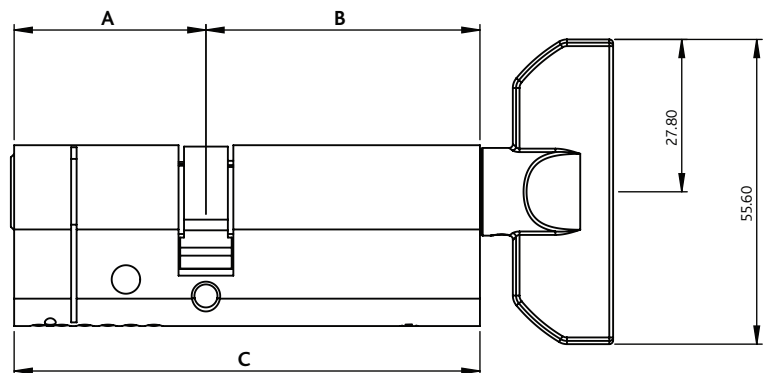

Diagram illustrates product in locked position. Not to scale. All dimensions are in mm and are nominal. ERA reserves the right to change specification without notice. It is the responsibility of the door manufacturer to ensure that the finished product meets any required safety and performance specification.

Classification

The Anti Bump cylinder has been approved to BS EN 1303:2015 and carries the following classification:

Category	1	2	3	4	5	6	7	8
Classification	1	6	0	0	0	C	5	2

Maintenance

Wipe the surface periodically with a soft cloth to remove excess grease or moisture.

Packaging

1 per kit

The TouchKey door lock is sold as a complete kit, please refer to the TouchKey solutions data sheet for further information.