



KABA®

SIMPLEX®

900 SERIES

INSTALLATION INSTRUCTIONS

KABA®

Kaba Access Control
2941 Indiana Avenue Winston-Salem, NC 27105 USA
Tel: (800) 849-8324 (336) 725-1331
Fax: (800) 346-9640 (336) 725-3269
www.kabaaccess.com

PKG1819 0307

Table of Contents

STEP	PAGE
Checklist/tools required	3
A Determining the lock handing	4
B Marking the door	4
C Drilling the holes	5
D Installing the key cylinder	5
E Installing the lock	6
F Installing the strike	7
G Testing the lock's operation	9
H Changing the combination	9
I Disassembling the lock/reversing the latch	11
J Instructions for resetting unknown combination	12
K Lever handle/panic hardware kits assembly instructions	13
L Troubleshooting	14
Warranty card	center of book
Template	back of book

Warning: The combination of this lock has been factory preset: II and IV depressed together, then III. For your security, the combination must be changed at time of installation.

Please read and follow all directions carefully

Since correct installation is critical, carefully check windows, frame, door, etc. to make sure that the recommended procedures will not cause any damage.

KABA is not responsible for any damage caused by installation.

For your records

Model No.: _____

Date Purchased: _____

Dealer: _____

Name: _____

Telephone: _____

Checklist Each 900 Series lock includes:

- A) Lock housing assembly
- B) Face plate with outside knob
- C) Strike plate (for outswing doors)
- D) Strike box (for inswing doors)
- E) Screw/accessory pack:
 - a) holding bracket
 - b) three 1 1/2" (38 mm) screws for the lock housing
 - c) two 1/2" (13 mm) screws for the holding bracket
 - d) Allen wrench
 - e) three 1" (25 mm) screws for the strike box
- F) Key override assembly Only included with key override models (906, 910, 935, 938).
 - f) cup flange
 - g) key cylinder with key
 - h) two screws and washers
 - i) thin metal spacer
 - j) trim ring
 - k) Spacer ring
- G) Surface Mount strike for steel door frames (purchased separately)

Tools required:

- Electric drill (variable speed recommended)
- Awl or center punch
- 1 5/8" (41 mm) Hole saw with pilot drill
- 7/8" (22 mm) Hole saw with pilot drill
- 1/8" (3 mm) Drill bit
- Hammer
- Phillips head screwdriver
- Small flat blade screwdriver
- 1" (25 mm) Chisel
- Pliers (2) for key override models only

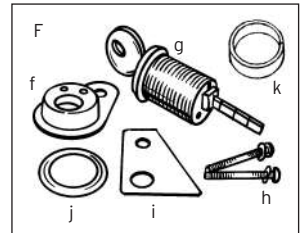
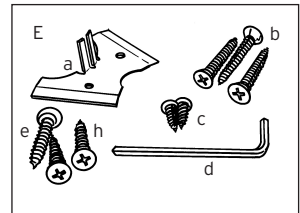
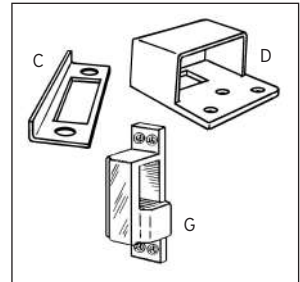
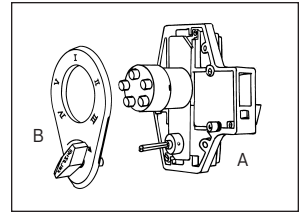

KABA®

For technical assistance please call
1-800-849-TECH (8324) or 336-725-1331

A. DETERMINING THE LOCK HANDING

Many of the installation instructions refer to the handing of your door, so you should determine the hand before starting the installation.

The hand of the door is determined with the door in the closed position, from the exterior (pushbutton side) of the door (**See Figure 1-1 and 1-2**).

RH - Right hand door. Door opens inward (push). Hinged on the right side.

LH - Left hand door. Door opens inward (push). Hinged on the left side.

RHRB - Right hand reverse bevel door. Door opens outward (pull). Hinged on the right side.

LHRB - Left hand reverse bevel door. Door opens outward (pull). Hinged on the left side.

Once you have determined the handing of your door, you should determine the distance above your existing primary lockset where the auxiliary lock will be mounted - 8" to 10" (203 mm to 254 mm) is recommended.

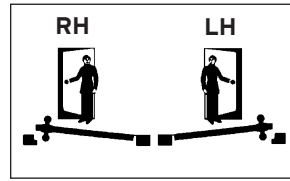

1-1

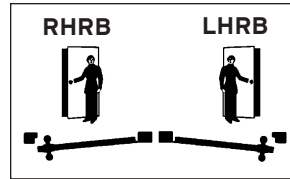

1-2

B. MARKING THE DOOR

The door must be closed.

B-1 Remove the template from the center of this booklet.

B-2 Fold the template on the solid line for an inswing door, if you are not using a riser plate. Fold the template on the dashed line for an outswing door, or if you are using a riser plate with an inswing door.

B-3 Tape the template securely to the inside surface of the door so that the indicated fold is aligned with the edge of the door **or door stop**, if one is present. **Figure 2-1** shows the inside of a left hand door; **Figure 2-2** shows the inside of a right hand door.

B-4 Use a center punch (or similar marking tool) to make the marks for drilling the five holes precisely at the points indicated on the template; there is a sixth hole (A) for key override models.

B-5 Remove the template.

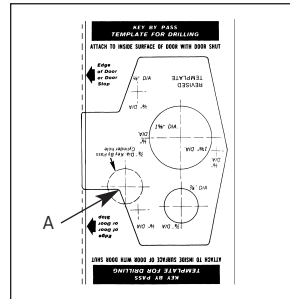

2-1

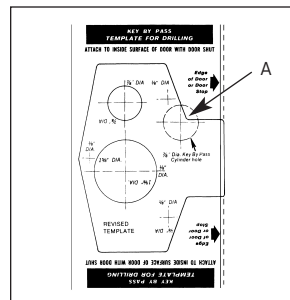

2-2

C. DRILLING THE HOLES

CAUTION: Positioning and drilling must be done straight to avoid excessive force being exerted on the lock which may result in the premature wearing of its mechanical parts.

NOTE: The latch is reversible on spring latch models 917, 919, 935, 938, and 929. Refer to the instructions in Section I, "Disassembling the Lock."

Use a variable speed drill to prevent splintering the door or breaking the drill bit. Begin drilling at a slow speed and increase the speed gradually until the tip of the pilot bit emerges through the other side of the door. Repeat this procedure from the opposite side of the door to complete the $\frac{7}{8}$ " (22 mm) and $1\frac{5}{8}$ " (41 mm) holes. Use a $\frac{1}{8}$ " (3 mm) drill bit to make pilot holes for the three mounting screws.

C-1 Drill the holes according to the template (**See Figure 3-1**; right hand door shown).

All models require 5 holes:

(A) one $\frac{7}{8}$ " (22 mm) hole

(B) one $1\frac{5}{8}$ " (41 mm) hole

(C) three $\frac{1}{8}$ " (3 mm) holes for the mounting screws. **Drill approximately $\frac{1}{2}$ " (13 mm) deep.**

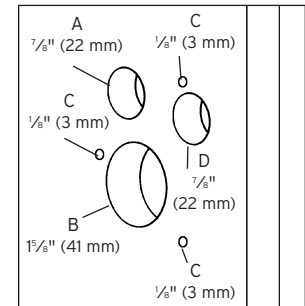

3-1

Key override models require one additional hole for the key cylinder:

(D) one $\frac{7}{8}$ " (22 mm) hole.

D. INSTALLING THE KEY CYLINDER

Shortening the cylinder tailpiece:

D-1 Determine the lock and riser plate you are using then select the break line from the table at right.

Lock A = Models 902, 906, 917, 935 for doors $1\frac{3}{8}$ " (35 mm) to $1\frac{1}{2}$ " (38 mm) thick

Lock B = Models 904, 910, 919, 938, 929 for doors $1\frac{3}{4}$ " (44 mm) to $2\frac{1}{8}$ " (54 mm) thick

D-2 Hold the tailpiece firmly with a pair of pliers (A) on the cylinder end of the tailpiece, just beside the desired break line (**See Figures 4-1 and 4-2**).

D-3 With a second pair of pliers (B), grip the tailpiece at the other side of the line and bend up and down until it breaks.

Lock	Riser Plate	Break Line
A	---	1
B	---	1
A	1/4" (6 mm) side	2
A	3/8" (10 mm) side	2
B	1/4" (6 mm) side	2
B	3/8" (10 mm) side	3

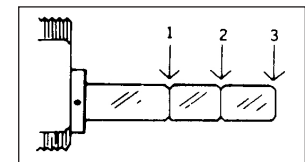

4-1

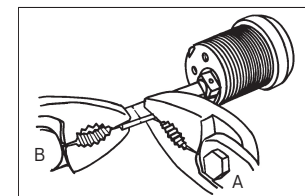

4-2

Installing the key cylinder:

D-4 (See Figure 4-3). Insert the cup flange (A) into the $\frac{7}{8}$ " (22 mm) hole on the inside of the door so that the hole in the flange of the cup (D) is over the $\frac{1}{8}$ " (3 mm) screw hole in the door.

D-5 Place the trim ring (B) onto the key cylinder shank, followed by the spacer (E) if needed.

D-6 Insert the key cylinder (C) through the $\frac{7}{8}$ " (22 mm) hole from the outside of the door. Make sure that the two holes in the cylinder are positioned at the top of the hole.

D-7 Secure the cup flange to the door with two screws (item h from checklist); the screws attach both the cup flange and the key cylinder to the door.

D-8 Place the thin metal plate over the key cylinder tailpiece and cup flange (on the inside of the door) so that the large hole fits over the large hole of the cup and the smaller hole fits over the $\frac{1}{8}$ " (3 mm) screw hole in the door (See Figure 4-4).

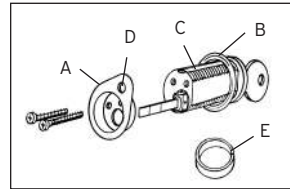

4-3

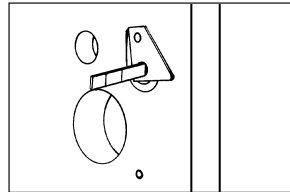

4-4

E. INSTALLING THE LOCK

E-1 From the inside of the door, slide the lock housing into the holes in the door (See Figure 5-1). Make sure the lock housing sits flush to the door.

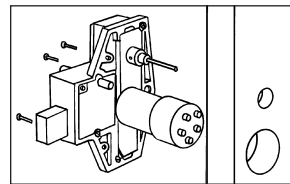

5-1

NOTE: The inside surfaces of some hollow metal doors are not even with the surfaces of their frames. An adjustable riser plate (Part #74468) is available to raise the lock housing $\frac{1}{4}$ " (6 mm) or $\frac{3}{8}$ " (10 mm) (See Figure 5-2).

E-2 Attach the lock housing to the door with the three $1\frac{1}{2}$ " (38 mm) mounting screws (item b on checklist) (See Figure 5-3).

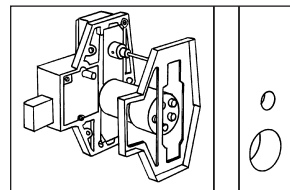

5-2

E-3 Place the holding bracket (A) with the slotted legs engaging the aligning pin (B) on the barrel assembly (C). Ensure that the large radius of the holding bracket is centered around the radius of the barrel assembly (See Figure 5-4).

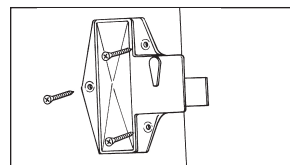

5-3

E-4 Fasten the holding bracket to the door with the two $\frac{1}{2}$ " (13 mm) screws (item c on checklist) (See Figure 5-4).

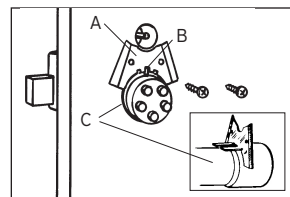

5-4

E-5 Remove the three screws holding the lock housing to the door, then remove the lock housing.

E-6 Slide the holding edges of the face plate (D) behind the formed-up edges of the holding bracket (A) (See Figure 5-5). Make sure that the face plate (D) is securely held on both sides.

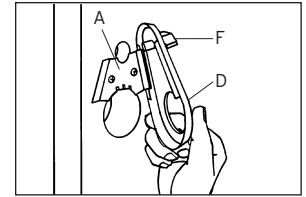

5-5

If you are installing a key override model, follow the instructions in Section D, "Installing the Key Cylinder," then return and continue these steps.

E-7 Turn the thumbturn (F) on the face plate to the vertical position and hold it in place (See Figure 5-5).

E-8 Replace the lock housing making sure that the force-proof clutch (E) engages the thumbturn (F) (See Figure 5-6).

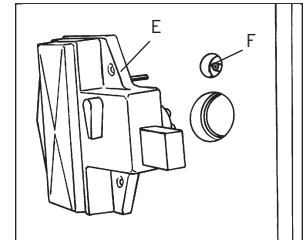

5-6

If you are installing a key override model, make sure the tailpiece of the key cylinder engages the cup on the gear plate.

E-9 Fasten the lock housing to the door with the three $1\frac{1}{2}$ " (38 mm) screws (See Figure 5-7).

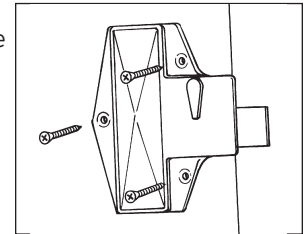

5-7

F. INSTALLING THE STRIKE

Inward Opening Door (wood frame) - mount box strike

F-1 Place the strike (A) on the door frame in line with the lock (See Figure 6-1).

F-2 Trace the outline of the strike on the door frame (B). Add $\frac{5}{32}$ " (4 mm) to the edge of the tracing (D) opposite the lock to allow for recessing of the strike tongue (C).

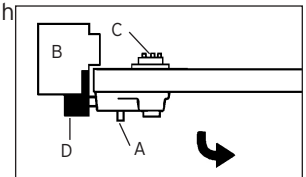

6-1

F-3 Chisel out the traced area.

F-4 Place the strike (A) back into this cutout and trace the outline of the strike tongue.

F-5 Chisel out the frame so that the strike tongue will be flush (See Figure 6-1).

F-6 Place the strike back into the cutout and check that the large segment of the latch enters the strike freely.

F-7 Secure the strike with three 1" (25 mm) screws (item e on checklist).

Outward Opening Door (wood frame) - mount flat strike

F-8 Place the strike (A) on the door frame (B) in line with the lock (**See Figure 6-2**).

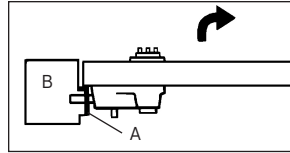

6-2

F-9 Trace the outline of the strike on the frame (B). Remove the strike.

F-10 Chisel out the frame (B) so that the strike will be flush with the frame.

F-11 Place the strike back into the cutout and trace the center bolt hole on the frame.

F-12 Chisel this out to clear the extended bolt. The bolt must enter the strike freely.

Spring Latch Models

The clearance between the lock housing and the strike must not exceed 1/8" (3 mm) to ensure deadlocking.

Outward Opening Door (metal frame) - for doors where the strike/frame is not prepped

F-13 With latch/bolt extended, gently close the door and mark the frame (B) where the latch/bolt is located.

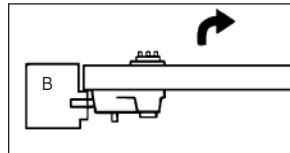

6-3

F-14 Open the door and carefully measure and mark the door stop where the latch/bolt will lock into the frame (**See Figure 6-3**).

F-15 Remove the material you have marked.

F-16 If using a spring latch model, make sure the dead locking latch can not fall into the latch/bolt hole.

Inward Opening Door (metal frame)

F-17 This application requires a surface mounted strike box (D) (74464) in place of the standard strike box (riser plate kit may be needed).

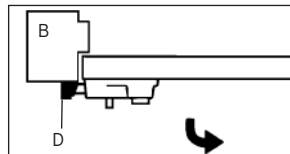

6-4

F-18 With latch/bolt extended, gently close the door and mark where the latch/bolt is located.

F-19 Align center of latch/bolt with center line of surface mount strike latch hole. Mark 4 mounting screw holes.

F-20 Drill surface strike mounting screw holes.

F-21 Attach surface mount strike (D) to frame with screws supplied (**See Figure 6-4**).

G. TESTING THE LOCK'S OPERATION

IMPORTANT: The following steps must be performed while the DOOR IS OPEN.

Unlocking the Door

G-1 Turn the outside thumbturn to the left (counterclockwise) to the stop position and release (**See Figure 7-1**).

G-2 Enter the preset combination (II and IV depressed together, release, then III, and release). Distinctive clicks must be felt to indicate that the buttons have been fully depressed (**See Figure 7-2**).

G-3 Turn the outside thumbturn to the right (clockwise) until it stops (**See Figure 7-3**); the latch/bolt should retract fully. If the latch/bolt does not retract, repeat steps G-1 to G-3.

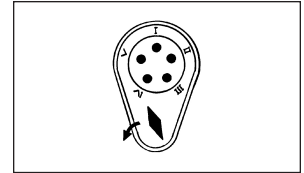

7-1

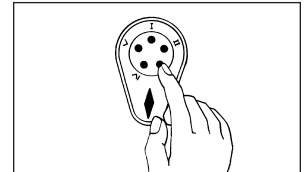

7-2

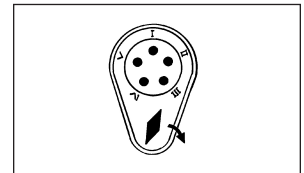

7-3

Unlocking the door using the key override

(models 906, 910, 935, 938)

Insert the key into the cylinder, turn the key to the right (clockwise) to the stop position, and open the door.

Locking the door - deadbolt models

Turn the outside knob to the left (counterclockwise) to the stop position; release.

Key override models 906, 910: turn the key to the left (counterclockwise) to the stop position; return the key to the pull position (vertical).

The bolt extends and locks the door.

NOTE: Spring latch models lock automatically when the door is closed; do not turn the outside knob or key.

H. CHANGING THE COMBINATION

FOR YOUR SECURITY THE COMBINATION MUST BE CHANGED WHEN THE LOCK IS INSTALLED.

The door must be open.

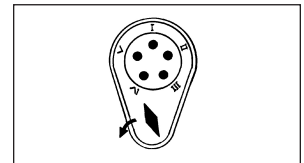

H-1 Turn the outside thumbturn to the left (counterclockwise) to the stop position and release. This will clear any random entries from the mechanism. When the thumbturn is turned to the left on a deadbolt model, the bolt is automatically thrown into the locked position; therefore, it is important to keep the door open while changing the combination.

KABA SIMPLEX® LIMITED WARRANTY

Kaba Access Control warrants this product to be free from defects in material and workmanship under normal use and service for a period of one (1) year. Kaba Access Control will repair or replace, at our discretion, locks found by Kaba Access Control analysis to be defective during this period. Our only liability, whether in tort or in contract, under this warranty is to repair or replace products that are returned to Kaba Access Control within the one (1) year warranty period.

This warranty is in lieu of and not in addition to any other warranty or condition, express or implied, including without limitation merchantability, fitness for purpose or absence of latent defects.

ATTENTION: This warranty does not cover problems arising out of improper installation, neglect or misuse. All warranties implied or written will be null and void if the lock is not installed properly and /or if any supplied component part is substituted with a foreign part. If the lock is used with a wall bumper, the warranty is null and void. If a doorstop is required, we recommend the use of a floor secured stop.

The environment and conditions of use determine the life of finishes on Kaba Access Control products. Finishes on Kaba Access Control products are subject to change due to wear and environmental corrosion. Kaba Access Control cannot be held responsible for the deterioration of finishes.

Authorization to Return Goods

Returned merchandise will not be accepted without prior approval. Approvals and Returned Goods Authorization Numbers (RGA Numbers) are available through our Customer Service department in Winston-Salem, NC (800) 849-8324. **The serial number of a lock is required to obtain this RGA Number.** The issuance of an RGA does not imply that a credit or replacement will be issued.

The RGA number must be included on the address label when material is returned to the factory. All component parts including latches and strikes (even if not inoperative) must be included in the package with return. All merchandise must be returned prepaid and properly packaged to the address indicated.

NO POSTAGE
NECESSARY
IF MAILED
IN THE
UNITED STATES

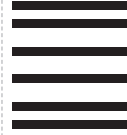
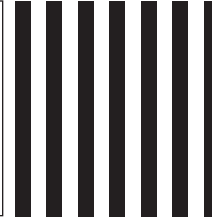

BUSINESS REPLY MAIL
FIRST-CLASS MAIL PERMIT NO. 1563 WINSTON-SALEM, NC

POSTAGE WILL BE PAID BY ADDRESSEE

KABA ACCESS CONTROL
2941 INDIANA AVENUE
WINSTON-SALEM, NC 27199-3770



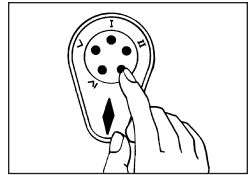

8-2

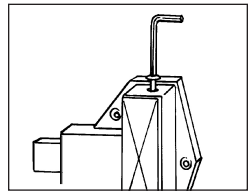

8-3

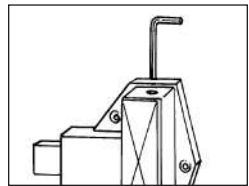

8-4

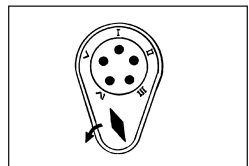

8-5

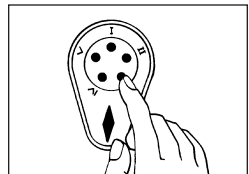

8-6

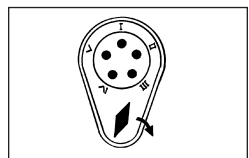

8-7

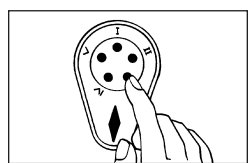

8-8

H-2 Enter the existing combination (**See Figure 8-2**). On new installations, use the factory-set combination: depress II and IV simultaneously, (release), then III (release). You should feel a slight click as each button is depressed.

H-3 Use the Allen wrench (item d on checklist) to remove the screw from the top of the lock housing (**See Figure 8-3**).

H-4 After removing the screw. Insert the Allen wrench into the hole and depress the internal lockout slide; (**See Figure 8-4**) you should feel a slight click. Do not force.

H-5 Remove the wrench.

H-6 Turn the outside thumbturn to the left (counter-clockwise) to the stop position and release (**See Figure 8-5**).

H-7 Choose your new combination, (be sure to write it down) then enter the new combination (**See Figure 8-6**) – depress buttons carefully (a slight click should be felt as each button is depressed).

Note: You can use one button or all five for a combination, but each button can only be used once. You can depress two or more buttons simultaneously as a step in the combination.

H-8 Turn the outside thumbturn to the right (clockwise) to the stop position and release (**See Figure 8-7**). The new combination is now set.

H-9 Test your new combination a few times **before** you shut the door (**See Figure 8-8**).

Lock and unlock the door following the instructions in Section F.

If the outside thumbturn retracts the latch or bolt and you have not entered your combination, steps were done out of order and the lock is in zero code.

H-10 Repeat H-1 to H-8, omitting step H-2, until the latch bolt retracts only after you enter your new combination.

H-11 Replace the screw on the top of the lock housing (**See Figure 8-3**).

NOTE: The outside thumbturn can not be forced to retract the latch/bolt because it is connected to the lock housing by a friction clutch. If the thumbturn has been forced, it can be turned back to the vertical position by hand without damaging the lock.

REGISTRATION CARD

Thank you for purchasing our product. In order to protect your investment and to enable us to better serve you in the future, please fill out this registration card and return it to Kaba Access Control, or register online at www.kabaaccess.com.

Name _____

Position _____

Company _____

Address _____

City _____

State _____ ZIP (Postal Code) _____ Country _____

Phone _____

Email _____

Name of Dealer Purchased From _____

Date of Purchase _____

Lock Model Number _____

This lock will be used in what type of facility?

- Commercial Building Industrial / Manufacturing Airport
- College/University Government/Military School/Educational
- Hospital/Healthcare Other (please specify) _____

What area is being secured with this lock? (e.g. Front Door, Common Door, Exercise Room)

This lock is:

- New Installation
- Replacing a conventional keyed lock
- Replacing a Kaba Mechanical Pushbutton Lock
- Replacing a Kaba Electronic Access Control
- Replacing a Keyless Lock other than Kaba

How did you learn about Kaba Access Control Pushbutton Locks?

- Advertisement Previous Use Internet / Web Another Use
- Locksmith Maintenance Training Class Other (please specify) _____

What was your reason for buying this lock? _____

Who installed your lock?

- Locksmith Maintenance Other _____

Check here if you would like more information on Kaba Access Control locks.

I. DISASSEMBLING THE LOCK/ REVERSING THE LATCH

You may need to disassemble the lock to reverse the latch on spring latch models or to clear a lost combination.

I-1 Remove the lock housing (A) from the inside of the door by removing the three mounting screws (See Figure 9-1).

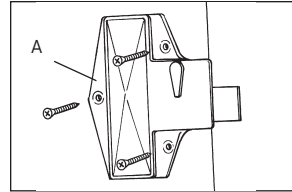

9-1

I-2 Remove the center plate and barrel assembly (B) by removing two screws and flange washers (See Figure 9-2 and 9-3).

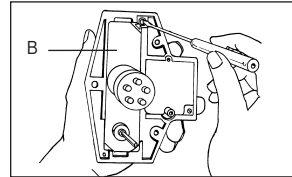

9-2

I-3 Remove the 2 gear plate screws (C) (See Figure 9-4).

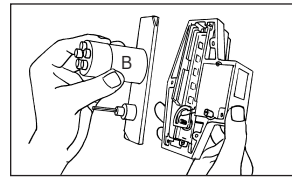

9-3

Note: Skip step I-4 if reversing the latch.

I-4 Remove the combination chamber (D) by removing one screw at each end of the chamber (See Figure 9-5).

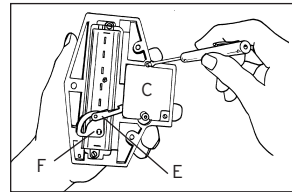

9-4

Reversing the Latch

I-5 Depress the latch and hold it.

I-6 Use the tip of a screwdriver to gently lift the gear plate by the exposed edge so you can grasp it with your fingertips.

I-7 (See Figure 9-4). Remove the gear plate (C) and place it aside. Note that the activating arm (E) is attached to the gear plate and will rise with the gear plate.

I-8 Release the latch slowly. Pull it out, reverse it, and reinsert it.

I-9 Depress the latch and hold it.

I-10 (See Figure 9-4) Reattach the gear plate (C). Make sure that the stud on the end of the activating arm (E) is resting in the curved slot on the throw cam (F).

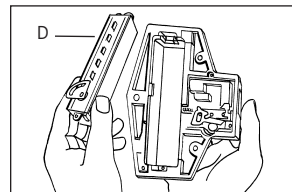

9-5

I-11 When the gear plate is flush with the back surface of the lock, release the latch and replace the screws attaching the gear plate.

I-12 Reassemble the center plate and barrel assembly (See Figure 9-2).

J. INSTRUCTIONS FOR RESETTING UNKNOWN COMBINATIONS

Follow the instructions in Section I, "Disassembling the lock." Remove the lock from the door and disassemble it as instructed (See Figure I-1 to I-4).

To remove the 3-sided dust cover marked "Kaba Simplex," place the combination chamber in the position below.

J-1 Place a small screwdriver on the edge of the 3-sided dust cover and push down on the screwdriver (See Figure 10-1). The cover should pop loose. Once it does, pull the cover off of the combination chamber.

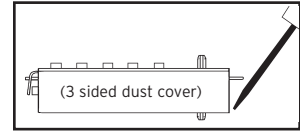

10-1

J-2 Hold the chamber in one hand by the screw tab (b) on each end with the key-stems (c) facing you and the control shaft (d) at the bottom (See Figure 10-2).

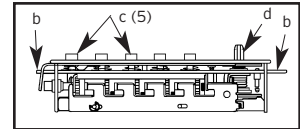

10-2

J-3 Using the sector (pie shaped cam) on the control shaft, rotate the control shaft (d) counter-clockwise and release to clear the chamber (See Figure 10-2).

J-4 Look at the 5 code gears (e). If any code gear pockets (f) are already at the shear line (open position), ignore them. They are not used in the combination (See Figure 10-3).

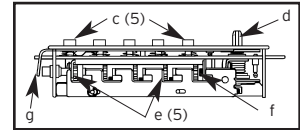

10-3

J-5 Find the code gear pocket (f) that is farthest away from the shear line (open position). Depress the key-stem (c) and release (See Figure 10-3). If any digits in the combination were depressed together (at the same time), then they must also be depressed together to reset the code.

J-6 Find the code gear pocket (f) that is the next farthest away from the shear line (open position). Depress that key-stem (c) and release (See Figure 10-3). If any of the code gear pockets travel past the shear line, the key stems have been depressed in the wrong sequence. Start over at Step J-3.

J-7 Repeat step J-6 until all code gear pockets (f) are at the shear line (open position).

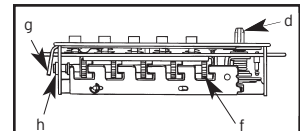

10-4

J-8 If all the code gear pockets (f) are not lined up at the shear line (open position), start over at step J-3.

J-9 Depress the lockout slide (g) at the top of the chamber and release. (looks like one end of a spark plug) (See Figure 10-4).

J-10 Rotate the control shaft (d) counter-clockwise to clear the chamber and release. The lockout slide (g) should pop out (button will not move yet) (See Figure 10-4).

J-11 Depress key-stem/s (c) 3 and 5 simultaneously, then 4, releasing each after it is depressed (See Figure 10-2).

J-12 Once you have depressed all the digits in this new combination, turn the control shaft (d) clockwise (**See Figure 10-4**). The code change button (h) under lockout slide (g), should pop up (**See Figure 10-4**). The combination is now set back to factory 2 and 4 together, then 3 (this will be evident once you have reassembled the center plate and barrel assembly).

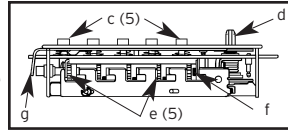

10-3

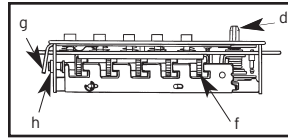

10-4

J-13 Look at the code gear pockets (f). The numbers in the combination should not be at the shear line (open position) (**See Figure 10-3**).

Reinstallation: Replace the 3-sided dust cover marked "Kaba Simplex." Make sure the staked joints on both end plates fit through the slots on the dust cover. Stake the end 2 plate joints. Replace the combination chamber into the lock reversing the steps in Section I (I-4 to I-1).

Testing: Enter the factory combination you preset during the reset process. Turn the outside thumbturn to the right (clockwise). The latch should retract. If the latch does not retract, turn the outside thumbturn left (counter-clockwise) and release, then enter the code again. The code must be changed from the factory code, using Section H in this book.

K. LEVER HANDLE / PANIC HARDWARE KITS ASSEMBLY INSTRUCTIONS

K-1 Assemble Part # 24124 Inside Stop (A) to housing with Part # 204112-022 Inside Stop Retaining screw (B). Assembly will be a force fit.

K-2 Assemble Part # 44133 Inside Insert (C). Half moon section of insert should rotate freely between stopping points of stop (**See Figure 11-1**).

K-3 Assemble Part # 34037 (B) Washer over housing side of insert (**See Figure 11-2**).

K-4 Assemble Lever Handle or Panic Hardware Rocker Arm over insert while lining up Roll Pin hole (**See Figure 11-2**).

K-5 Insert Part # 54166 Roll Pin (C). Assembly will be a force fit (**See Figure 11-2**).

K-6 Test Lever Handle / Panic hardware rocker arm for rotational free movement.

(A) = $\frac{\text{Part \#74200 - Panic Hardware}}{\text{Part \#44105 - Inside Lever Handle}}$

(D) = Inside Housing

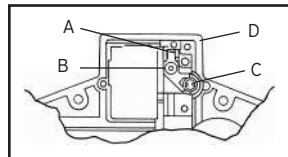

11-1

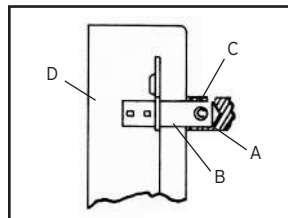

11-2

L. TROUBLESHOOTING

- ? Latch/bolt fails to retract when access code is pressed and outside thumbturn is rotated clockwise.
- Buttons were not fully depressed when the access code was entered.
- ☞ Turn thumbturn counterclockwise to stop position and try to retract the latch/bolt again.
- ? Turning outside thumbturn always retracts latch/bolt without depressing any buttons.
- Lock is in zero combination.
- ☞ Follow the procedure for changing the combination in Section H, but omit step H-2.
- ? Inside knob only retracts latch/bolt partially or not at all.
- Holes were not drilled straight or were not drilled in proper location.
- Door thickness is not appropriate for this model.
- ☞ Recheck the holes and file so lock does not bind.
- ☞ Make sure correct model was ordered and installed.
- ? After setting a new combination, the lock works one time only, then fails to open.
- Buttons of intended combination were not fully depressed when changing combination.
- ☞ This is a lost combination situation. Follow instructions in Section J.

KABA®

For technical assistance please call
1-800-849-TECH (8324) or 336-725-1331

Fold along dash line for outswinging door or if you are using a riser plate on an inswinging door
Fold along solid line for inswinging door (no riser plate) See step 2 in instructions

* Drill only if lock model has key override function

TOP FOR RIGHT HAND DOORS

Door handing should be determined before door prep is started to avoid incorrect door preparation.

TOP FOR LEFT HAND DOORS

Attach to inside surface of shut door

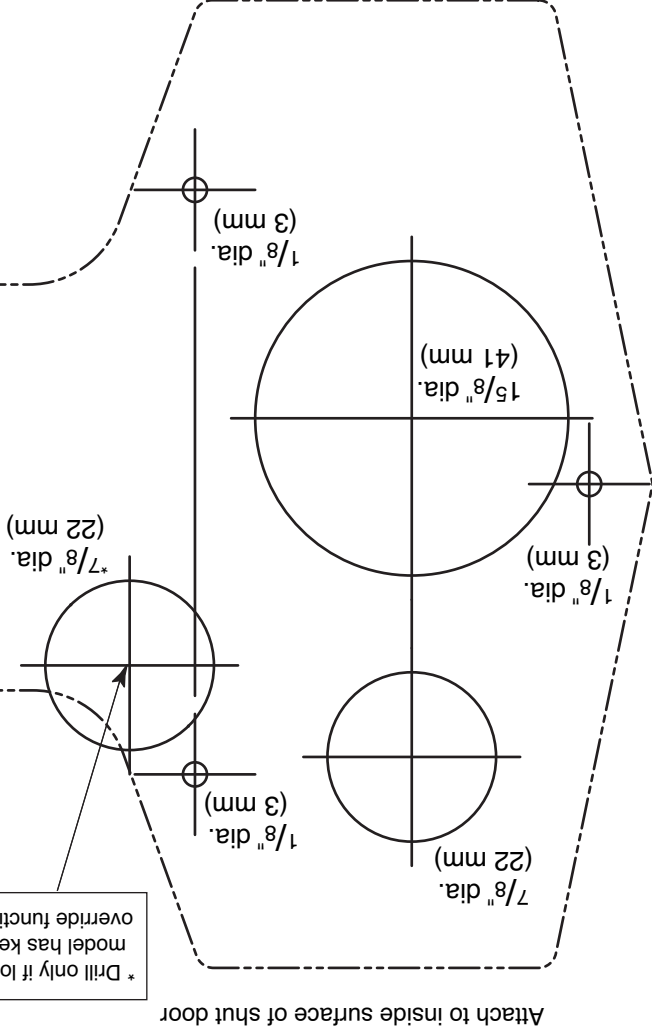

Notes
