

Sash Heritage 50mm Sash Screw

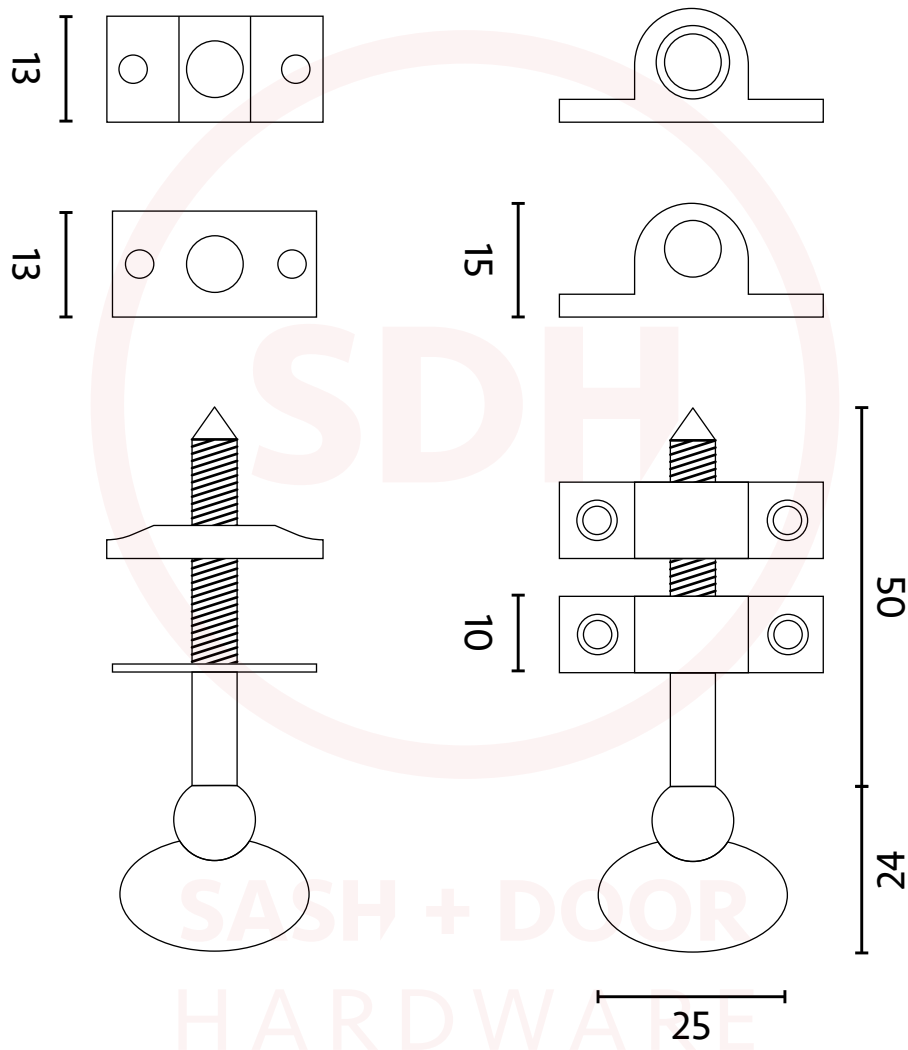

NOTE : This product is made from Cast Brass and manufactured using the Traditional Sand Cast method. The items requiring a Lacquer protection are protected using the Electrophoretically Lacquered process giving a very attractive long-lasting product. When cleaning the product, use a cloth soaked in warm soapy water and dry off using clean dry cloth - Do not use any chemical cleaners as this will harm the product and will break down the lacquer and tarnish the product. Due to the nature of the manufacturing process, a tolerance of + / - 5 % must be allowed on the weight and dimensions given on this product.